

PEGASUS

sporgenza max | **max projection** | maximale Ausladung
avancée maximale | salida máx | saliência máxima

350 cm

arm
projection 

- 150 cm
- 175 cm
- 200 cm
- 225 cm
- 250 cm
- 275 cm
- 300 cm
- 325 cm
- 350 cm

AVAILABLE COLOURS

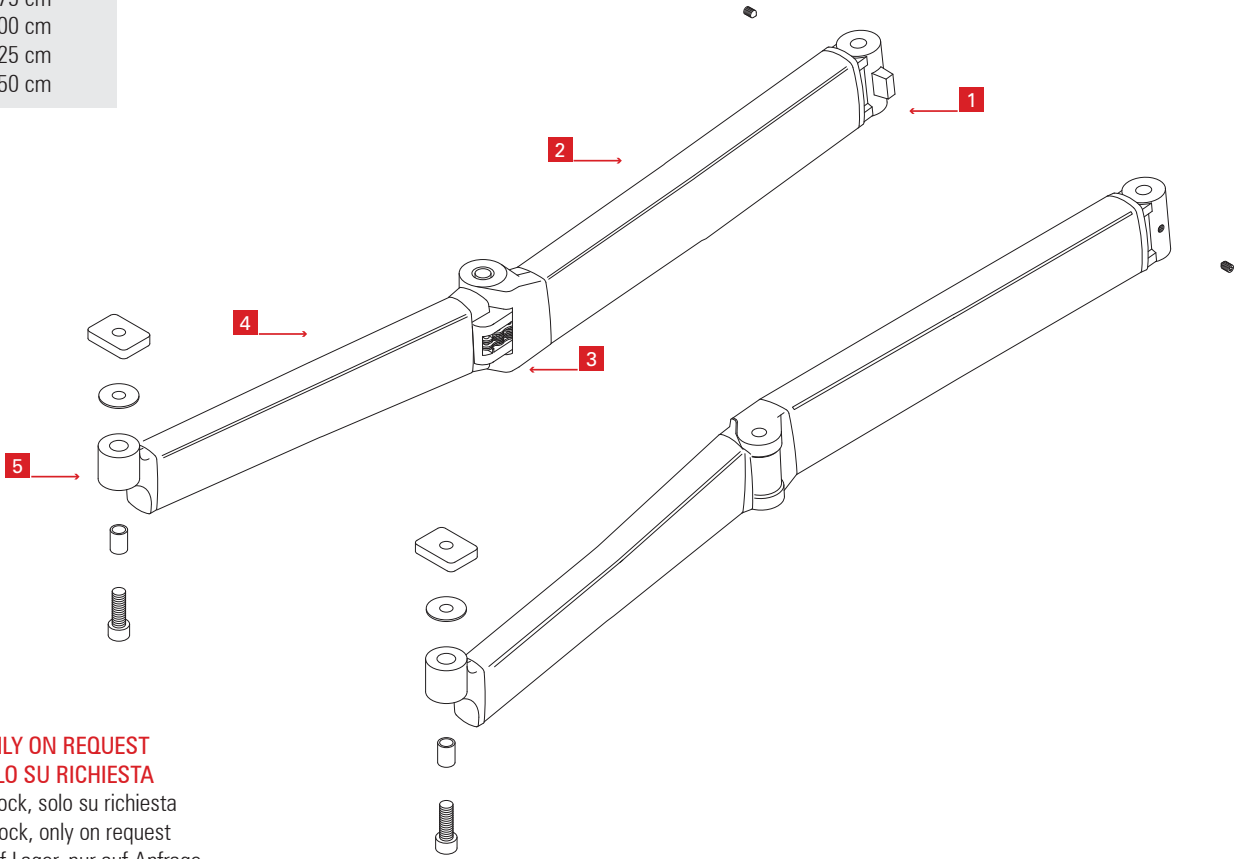

**! ONLY ON REQUEST
SOLO SU RICHIESTA**
non a stock, solo su richiesta
not in stock, only on request
Nicht auf Lager, nur auf Anfrage
pas en stock, uniquement sur demande
no en stock, solo bajo pedido
não em estoque, apenas a pedido

AVAILABLE FOR AWNING

disponibile per tenda
available for awning

- RAFFAELLO
- MODIGLIANI
- BALLA
- TIZIANO
- BOCCIONI
- DE CHIRICO

Erhältlich für folgende Markisen
disponible pour store

- TIEPOLO
- RENOIR
- GIORGIONE
- PERUGINO

disponibile para toldo
disponibilidade por toldo

- GIOTTO
- GIOTTO MILLENNIUM
- MANTEGNA
- MANTEGNA MILLENNIUM
- ARCIMBOLDO
- ARCIMBOLDO BQ

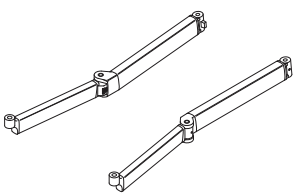

- 2XL150P
- 2XL175P
- 2XL200P
- 2XL225P
- 2XL250P
- 2XL275P
- 2XL300P
- 2XL325P
- 2XL350P



- braccio pegasus
- pegasus arm
- Gelenkarm Pegasus
- bras pegasus
- brazo pegasus
- braço pegasus



- 150 cm
- 175 cm
- 200 cm
- 225 cm
- 250 cm
- 275 cm
- 300 cm
- 325 cm
- 350 cm



1 CP



**! ONLY ON REQUEST
SOLO SU RICHIESTA**



N° 

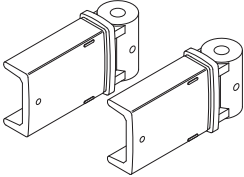
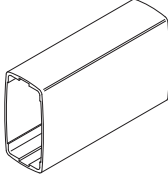
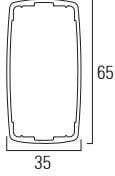
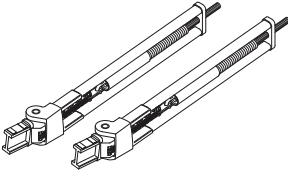
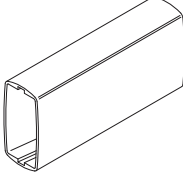
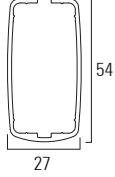
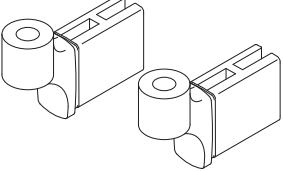

1		2XL900B	spalla standard standard abutment Standard Leibung épaule standard hombro standard hombro standard				1 CP	
2		EXSD02L7000	profilo superiore standard standard upper profile Standard Oberprofil profil superieur standard perfil superior standard perfil superior standard		700 cm		1 PZ	
3		2XL907B 2XL907C 2XL907E 2XL907D	cartuccia pegasus pegasus cartridge Pegasus-Kartusche cartouche pegasus cartucho pegasus cartucho pegasus		150-225 250-275 300-325 350 cm		1 CP	
4		EXMGSD01L7000	profilo inferiore standard standard lower profile Standard Unterprofil profil inferieur standard perfil inferiorstandard perfil inferior standard		700 cm		1 PZ	
5		2XL900CP	puntale pipetta standard standard pipette tip Standard Spitze mit Pipette pointe pipette standard punta pipeta standard ponteira pipeta standart				1 CP	

OPTIONAL

optional disponibili per questo braccio
extras available for this arm type

vorhandene Möglichkeiten für diesen Arm
options disponibles pour ce bras

opciones disponibles para este brazo
opções disponíveis para este braço

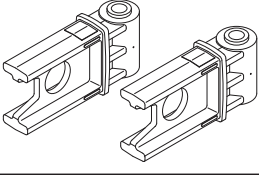
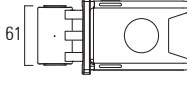
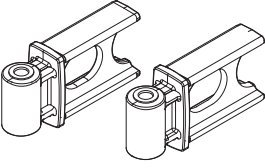
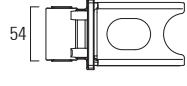
	2XL900BDV	spalla standard maggiorata standard bigger abutment Standard Vergrößerte Leibung épaule standard majoré hombro standard aumentado hombro standart aumentado					1 CP	
	2XL9000M	spalla om om abutment Leibung Om épaule om hombro om hombro om					1 CP	