

ANTONELLI

larghezza max | max width cm | Max. Breite cm
 largeur max cm | ancho máx cm | largura max cm

480 cm

altezza max | max height | maximale Höhe
 hauteur max | salida máx | saliência máxima

340 cm

sporgenza max | max projection | maximale Ausladung
 avancée maximale | salida máx | saliência máxima

140 cm

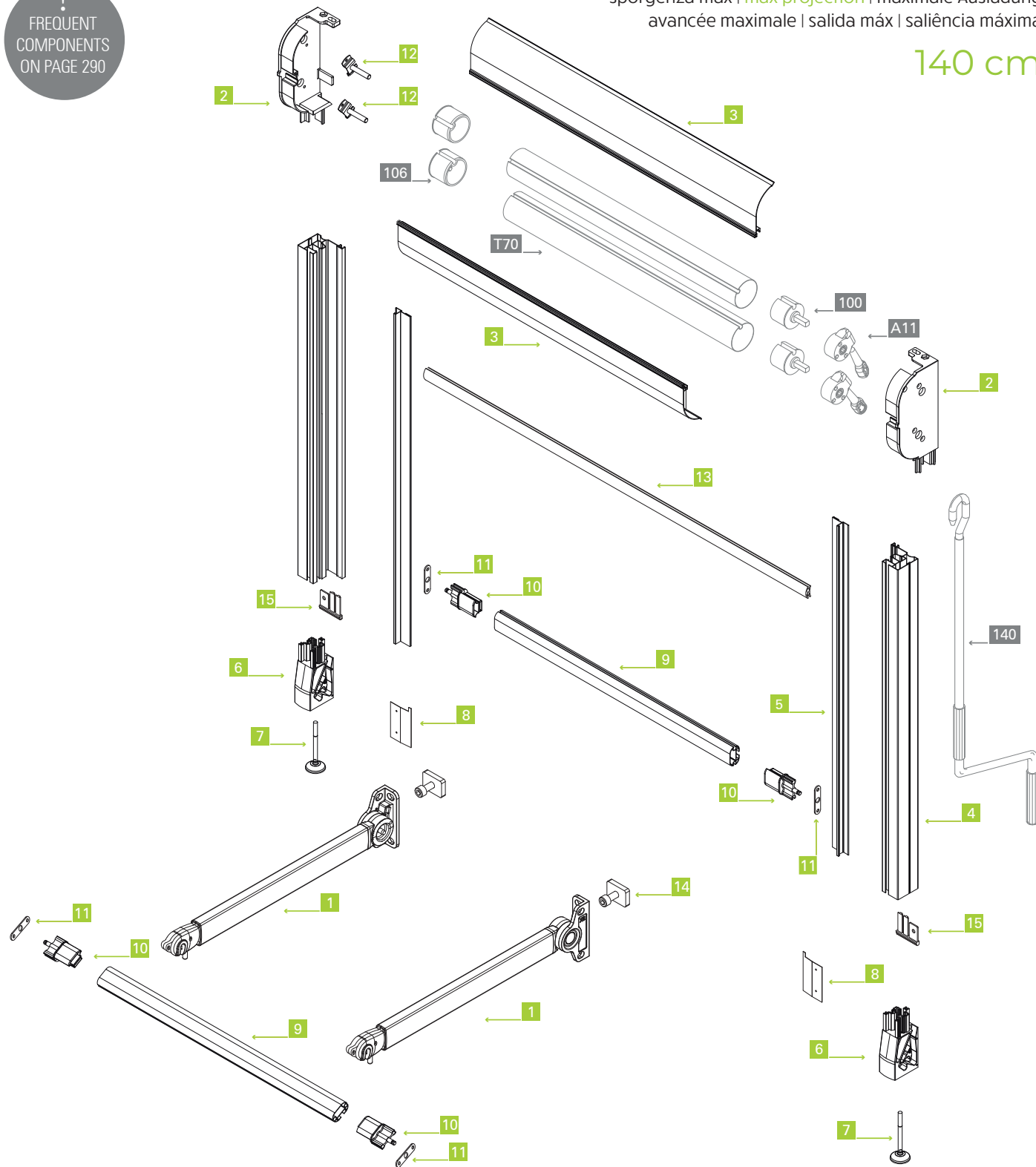

!
 FREQUENT
 COMPONENTS
 ON PAGE 290







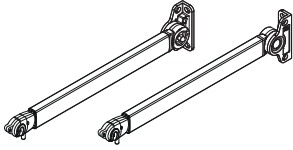
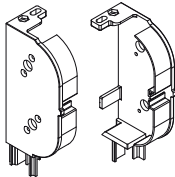
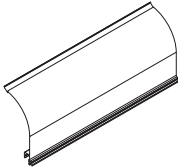
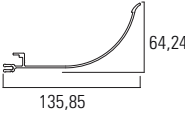
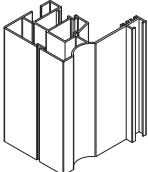
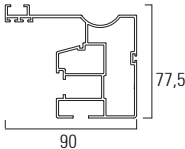

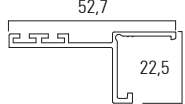
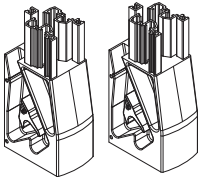
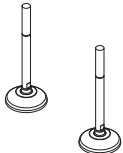
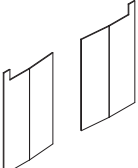
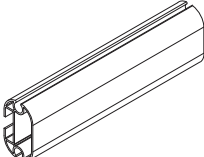
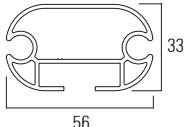
AVAILABLE COLOURS
 RAL 9010 7035

N° 

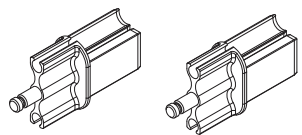
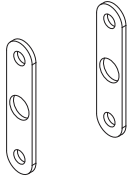
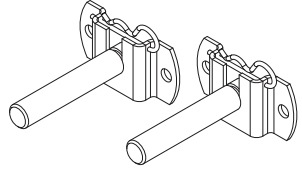
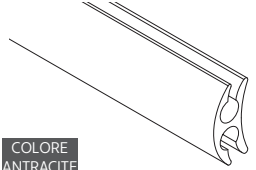
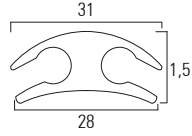
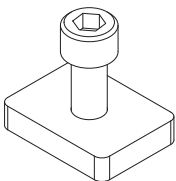
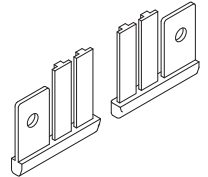

1		<p>10XLAN070 10XLAN080 10XLAN100 10XLAN120 10XLAN140</p>	<p>braccio antonelli antonelli arm Gelenkarm Antonelli bras antonelli brazo antonelli braço antonelli</p>	<p>70 cm 80 cm 100 cm 120 cm 140 cm</p>	<p>1 CP</p>	
2		<p>10XLATES</p>	<p>testata antonelli header antonelli Kopfstoß Antonelli tête antonelli cabecera antonelli cabeçada antonelli</p>		<p>1 CP</p>	
3		<p>10XLACOPL7000</p>	<p>profilo cassonetto antonelli antonelli cassette profile Kassettenprofil Antonelli profil coffre antonelli perfil cajón antonelli perfil caixote antonelli</p>	 <p>64,24 135,85</p>	<p>700 cm 1 PZ</p>	
4		<p>10XLAGUIL5400</p>	<p>guida antonelli antonelli profile guide Führung Antonelli glissière antonelli guia antonelli guia antonelli</p>	 <p>77,5 90</p>	<p>540 cm 1 PZ</p>	<p>2 PZ </p>
5		<p>10XLAALGL5400</p>	<p>aletta per guida antonelli antonelli fin for guide Verschlussprofil für Führung Antonelli nageoire pour glissière antonelli aleta por guía antonelli alhetta para guia antonelli</p>	 <p>52,7 22,5</p>	<p>540 cm 1 PZ</p>	
6		<p>10XLAPIE</p>	<p>piede antonelli con linguetta antonelli foot with tab Bodenbefestigung Antonelli mit Klappe ped antonelli avec languette pie antonelli con lengüeta pé antonelli com lingueta</p>		<p>1 CP</p>	
7		<p>10XLAPRG</p>	<p>spessore registrabile per piede antonelli adjustable wedge for antonelli foot Keil für Füßchen Antonelli cale régable pour pied antonelli cuña ajustable por pie antonelli cunha Registrável para pé antonelli</p>		<p>1 CP</p>	
8		<p>10XLAPCP</p>	<p>parete copertura antonelli plate for foot antonelli Plättchen für Füßchen Antonelli plaquette pour pied antonelli plaquita para pie antonelli pratinho para pé antonelli</p>		<p>1 CP</p>	
9		<p>10XLATERL7000</p>	<p>profilo terminale antonelli antonelli terminal bar Ende-Ausfallprofil Antonelli profil barre de charge antonelli perfil barra de carga antonelli perfil terminal antonelli</p>	 <p>33 56</p>	<p>700 cm 1 PZ</p>	

N°						
10						1 CP
11						1 CP
12						1 CP
13	 <small>COLORE ANTRACITE</small>				700 cm	1 PZ
14						1 PZ
15						1 CP

KIT ANTONELLI

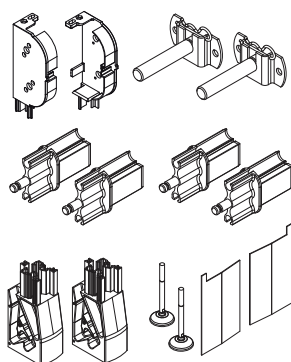
kit antonelli
antonelli kitkit Antonelli
kit antonellikit antonelli
kit antonelli

10XLANTKIT

kit antonelli
antonelli kit
kit Antonelli
kit antonelli
kit antonelli
kit antonelli
$$2 + 6 +$$

$$7 + 8 +$$

$$10(x2) + 12$$

1 PZ

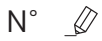

OPTIONAL

optional disponibili per questa tenda
extras available for this awning

vorhandene Möglichkeiten für diese Markise
options disponibles pour ce store

opciones disponibles para este toldo
opções disponíveis para este toldo

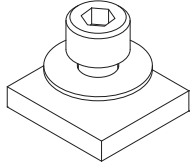

2XLPSTCA

piastrina 25x27x5 Ø8 - rondella per cassonetto antonelli
plate 25x27x5 Ø8 - washer for antonelli cassette profile
Plättchen 25x27x5 Ø8 - Unterlegscheibe für Kassettenprofil Antonelli
plaquette 25x27x5 Ø8 - rondelle pour profile coffre
plaquita 25x27x5 Ø8 - arandela para perfil cajón antonelli
pratinho 25x27x5 Ø8 - arruela por perfil caixote antonelli

1 PZ



10XLALID

linguetta di deviazione per piede antonelli
deflection lid for antonelli small foot
Abweichungs-Klappe für Füßchen Antonelli
languette de déviation pour pied antonelli
lengüeta de desviación por pie antonelli
lingueta de desvío para pé antonelli

1 PZ