

# GIOTTO MILLENNIUM

sporgenza max | max projection | max. Ausladung  
avancée max. | salida máx | saliência máx.

300 cm

**GIOTTO MILLENNIUM** Una tenda a bracci con cassonetto dal design innovativo grazie all'utilizzo di nuovi componenti con led RGB integrato. Tre configurazioni: **SPECIAL**, **LUX** e **FULL LED**, per accendere il tuo ambiente in tre modi diversi!

**GIOTTO MILLENNIUM** Folding arm cassette awning with innovative design thanks to the use of new components with integrated RGB LED. Three setup: **SPECIAL**, **LUX** and **FULL LED**, to light up your space in three different ways.

**GIOTTO MILLENNIUM** Kassettenmarkise mit innovativem Design dank der Verwendung neuer Komponenten mit integrierter RGB-LED. Drei verschiedene Einstellungen: **SPECIAL**, **LUX** und **FULL LED**, um Ihren Raum auf drei verschiedene Arten zu beleuchten.

## GIOTTO MILLENNIUM - SPECIAL

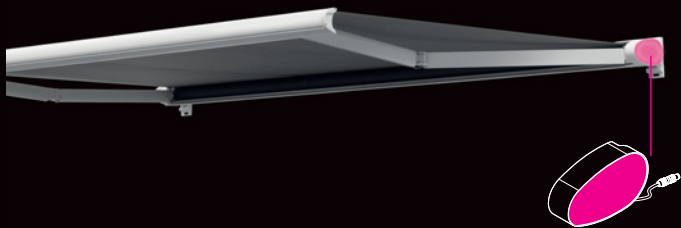

**GIOTTO MILLENNIUM - SPECIAL** Ha la testata laterale in vetro opaco che si può illuminare del colore che vuoi, regolandone l'intensità. La testata è allacciata a un trasformatore con centralina ed è comandata da un telecomando o da apposita app sullo smartphone (IOS e ANDROID).

**GIOTTO MILLENNIUM - SPECIAL** Shows a side header in opaque glass that can light up in the colour you prefer, adjusting its intensity. The header is connected to a transformer with a control box and you can control it using a remote controller or using a special app on your smartphone (IOS and ANDROID).

**GIOTTO MILLENNIUM - SPECIAL** Zeigt eine seitliche Kopfstoß aus undurchsichtigem Glas, die in der von Ihnen bevorzugten Farbe leuchten kann und deren Intensität Sie einstellen können. Der Kopfstoß ist an einen Transformator mit Schaltkasten angeschlossen und kann über eine Fernbedienung oder eine spezielle App auf Ihrem Smartphone (IOS und ANDROID) gesteuert werden.

**GIOTTO MILLENNIUM - SPECIAL** Présente la tête latéral en verre opaque qui peut s'illuminer dans la couleur que vous préférez, en réglant l'intensité. La tête latéral est relié à un transformateur avec unité de contrôle et vous pouvez la contrôler avec un télécommande ou avec une application spéciale sur votre smartphone (IOS et ANDROID).

**GIOTTO MILLENNIUM - SPECIAL** Muestra una cabecera lateral de cristal opaco que puede iluminarse en el color que prefieras, regulando su intensidad. El cabezera está conectado a un transformador con caja de control y puedes controlarlo con un mando a distancia o mediante una app especial en tu smartphone (IOS y ANDROID).

**GIOTTO MILLENNIUM - SPECIAL** Apresenta uma cabeçada lateral em vidro opaco que pode iluminar-se na cor que preferir, regulando a sua intensidade. O cabeçalho está ligado a um transformador com uma caixa de controlo e pode ser controlado através de um controlo remoto ou através de uma aplicação especial no seu smartphone (IOS e ANDROID).

**GIOTTO MILLENNIUM** Store à bras avec coffre au design innovant grâce à l'utilisation de nouveaux composants avec LED RVB intégrées. Trois configurations: **SPECIAL**, **LUX** et **FULL LED**, pour éclairer votre espace de trois manières différentes.

**GIOTTO MILLENNIUM** Toldo con brazos con cajón con un diseño innovador gracias al uso de nuevos componentes con LED RGB integrados. Tres configuraciones: **SPECIAL**, **LUX** y **FULL LED**, para iluminar su espacio de tres formas diferentes.

**GIOTTO MILLENNIUM** Toldo com braço e caixa com design inovador graças à utilização de novos componentes com LED RGB integrado. Três configurações: **SPECIAL**, **LUX** e **FULL LED**, para iluminar o seu espaço de três maneiras diferentes.

## GIOTTO MILLENNIUM - LUX

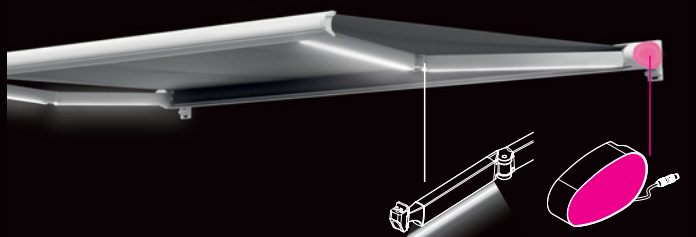

**GIOTTO MILLENNIUM - LUX** All'elemento di design della testata laterale del modello Special, si aggiunge l'installazione di una coppia di bracci led con luce bianca dimerabile per accendere l'ambiente esterno notturno. I bracci sono allacciati a un trasformatore con centralina con un filo di ingresso separato rispetto a quello della testata RGB. Bracci e sistema RGB possono essere comandati indipendentemente, sia da telecomando sia da apposita app sullo smartphone.

**GIOTTO MILLENNIUM - LUX** In addition to the side RGB header, as in the model Special, it shows the installation of LED arms with dimerabile white light to light up the outdoor space in the night. The arms are connected to a transformer with a control unit with a separate input wire from that of the RGB header. They can be controlled independently of each other, either by remote controller or by special app on the smartphone.

**GIOTTO MILLENNIUM - LUX** Zusätzlich zum seitlichen RGB- Kopfstoß, wie beim Modell Special, zeigt es die Installation von LED-Armen mit dimerablem weißem Licht, um den Außenbereich in der Nacht zu beleuchten. Die Arme sind an einen Transformator mit einer Steuereinheit angeschlossen, deren Eingangskabel von dem des RGB-Headers getrennt ist. Sie können unabhängig voneinander gesteuert werden, entweder über eine Fernbedienung oder über eine spezielle App auf dem Smartphone.

**GIOTTO MILLENNIUM - LUX** En plus de la tête latéral RGB, comme dans le modèle Special, la store montre l'installation de bras LED avec lumière blanche dimerable pour éclairer l'espace extérieur dans la nuit. Les bras sont connectés à un transformateur doté d'une unité de commande dont le fil d'entrée est distinct de celui du collecteur RVB. Ils peuvent être contrôlés indépendamment les uns des autres, soit par une télécommande, soit par une application spéciale sur le smartphone.

**GIOTTO MILLENNIUM - LUX** Además de la cabecera lateral RGB, como en el modelo Special, presenta la instalación de brazos LED con luz blanca dimerable para iluminar el espacio exterior por la noche. Los brazos están conectados a un transformador con una unidad de control con un cable de entrada independiente del cabezal RGB. Pueden controlarse independientemente unos de otros, ya sea por mando a distancia o mediante una aplicación especial en el smartphone.

**GIOTTO MILLENNIUM - LUX** Para além da cabeçada lateral RGB, como no modelo Special, apresenta a instalação de braços LED com luz branca dimerizável para iluminar o espaço exterior durante a noite. Os braços estão ligados a um transformador com uma unidade de controlo com um fio de entrada separado do do header RGB. Podem ser controlados independentemente uns dos outros, quer por controlo remoto, quer por uma aplicação especial no smartphone.



AVAILABLE COLOURS  +10%  
RAL 9010 ANTRACITE

! anthracite only with 600 cm profiles and galaxy plus arm

## GIOTTO MILLENNIUM - FULL LED

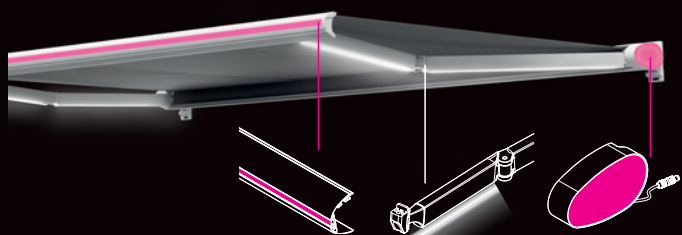

A TRULY  
**PERFECT DISPLAY**

**GIOTTO MILLENNIUM - FULL LED:** uno spettacolo assolutamente perfetto. La configurazione si completa con un sistema di illuminazione RGB anche sul profilo terminale a misura della larghezza tenda. Un unico sistema RGB per terminale e testate, coordinato nell'accensione, nel colore e nell'intensità.

Il terminale Giotto Millennium è predisposto per la sede del led, che una volta inserito, va ricoperto con un'opalina trasparente opaca. FULL LED prevede l'utilizzo di appositi bracci led con luce bianca dimmerabile, provvisti di un secondo cavo che passa all'interno di uno dei due bracci e alimenta il terminale della tenda. Scegli con attenzione il braccio con cavo aggiuntivo a destra o sinistra.

Bracci e sistema RGB possono essere comandati indipendentemente, sia da telecomando sia da apposita app sullo smartphone (IOS e ANDROID).

**GIOTTO MILLENNIUM - FULL LED:** is a perfect show. The setup is completed with an RGB lighting system also on the terminal bar across the entire awning's width. A single RGB system for terminal bar and side headers, coordinated in lighting, colour and intensity.

The Giotto Millennium terminal bar is prepared for the LED housing to cover with a transparent matte opaline.

FULL LED includes the use of special LED arms with dimmerable white light, provided with a second cable that runs inside one of the arms and powers the awning's terminal bar. Choose carefully the arm with additional cable on the right or left.

Arms and RGB system can be controlled independently, either by remote controller or by special app on the smartphone (IOS and ANDROID).

**GIOTTO MILLENNIUM - FULL LED:** ist eine perfekte Show. Vervollständigt wird die Ausstattung durch ein RGB-Beleuchtungssystem, das sich auch an der Endleiste über die gesamte Breite der Markise erstreckt. Ein einziges RGB-System für die Endleiste und die seitlichen Kopfstücke, abgestimmt in Beleuchtung, Farbe und Intensität.

Die Endleiste Giotto Millennium ist für die Abdeckung des LED-Gehäuses mit einer transparenten, matten Opalschicht vorbereitet.

FULL LED beinhaltet die Verwendung von speziellen LED-Armen mit dimerbarem weißem Licht, die mit einem zweiten Kabel versehen sind, das in einem der Arme verläuft und die Klemmleiste der Markise versorgt. Wählen Sie sorgfältig den Arm mit zusätzlichem Kabel auf der rechten oder linken Seite.

Die Arme und das RGB-System können unabhängig voneinander gesteuert werden, entweder über eine Fernbedienung oder über eine spezielle App auf dem Smartphone (IOS und ANDROID).

**GIOTTO MILLENNIUM - FULL LED:** un spectacle parfait. L'installation est complétée par un système d'éclairage RGB également sur le profil barre de charge, sur toute la largeur de la store. Un seul système RGB pour le profil de barre de charge et les têtes latérales, coordonné en termes d'éclairage, de couleur et d'intensité.

Le profil de charge Giotto Millennium est préparée pour recevoir le boîtier des LED en le recouvrant d'une opaline transparente et mate.

Le système FULL LED prévoit l'utilisation de bras spéciaux à LED à lumière blanche dimerable, munis d'un second câble qui passe à l'intérieur d'un des bras et alimente la barre terminale de la store. Choisissez avec soin le bras avec le câble supplémentaire à droite ou à gauche.

Les bras et le système RGB peuvent être contrôlés indépendamment, soit par une télécommande, soit par une application spéciale sur le smartphone (IOS et ANDROID).

**GIOTTO MILLENNIUM - FULL LED:** es un espectáculo perfecto. La instalación se completa con un sistema de iluminación RGB también en la barra terminal en toda la anchura del toldo. Un único sistema RGB para barra terminal y cabeceras laterales, coordinado en iluminación, color e intensidad.

La barra terminal Giotto Millennium está preparada para que la carcasa de los LED se cubra con una opalina mate transparente.

FULL LED incluye el uso de brazos LED especiales con luz blanca dimerable, provistos de un segundo cable que pasa por el interior de uno de los brazos y alimenta la barra terminal del toldo. Elija cuidadosamente el brazo con cable adicional a la derecha o a la izquierda.

Los brazos y el sistema RGB se pueden controlar de forma independiente, ya sea con el mando a distancia o con una aplicación especial en el smartphone (IOS y ANDROID).

**GIOTTO MILLENNIUM - FULL LED:** é um espetáculo perfeito. A configuração é completada com um sistema de iluminação RGB também na barra terminal em toda a largura do toldo. Um único sistema RGB para a barra terminal e para os cabeçalhos laterais, coordenado em termos de iluminação, cor e intensidade.

A barra terminal do Giotto Millennium é preparada para o alojamento dos LED para cobrir com um opalino transparente mate.

O sistema FULL LED prevê a utilização de braços LED especiais com luz branca dimerizável, dotados de um segundo cabo que passa no interior de um dos braços e alimenta a barra terminal do toldo. Escolha cuidadosamente o braço com cabo adicional à direita ou à esquerda.

Os braços e o sistema RGB podem ser controlados de forma independente, quer através do controlo remoto, quer através de uma aplicação especial no smartphone (IOS e ANDROID).

# GIOTTO MILLENNIUM - SPECIAL

sporgenza max | max projection | maximale Ausladung  
avancée maximale | salida máx | saliência máxima

300 cm

AVAILABLE COLOURS RAL 9010 +10%  
ANTRACITE

 anthracite only with 600 cm profiles and galaxy plus arm

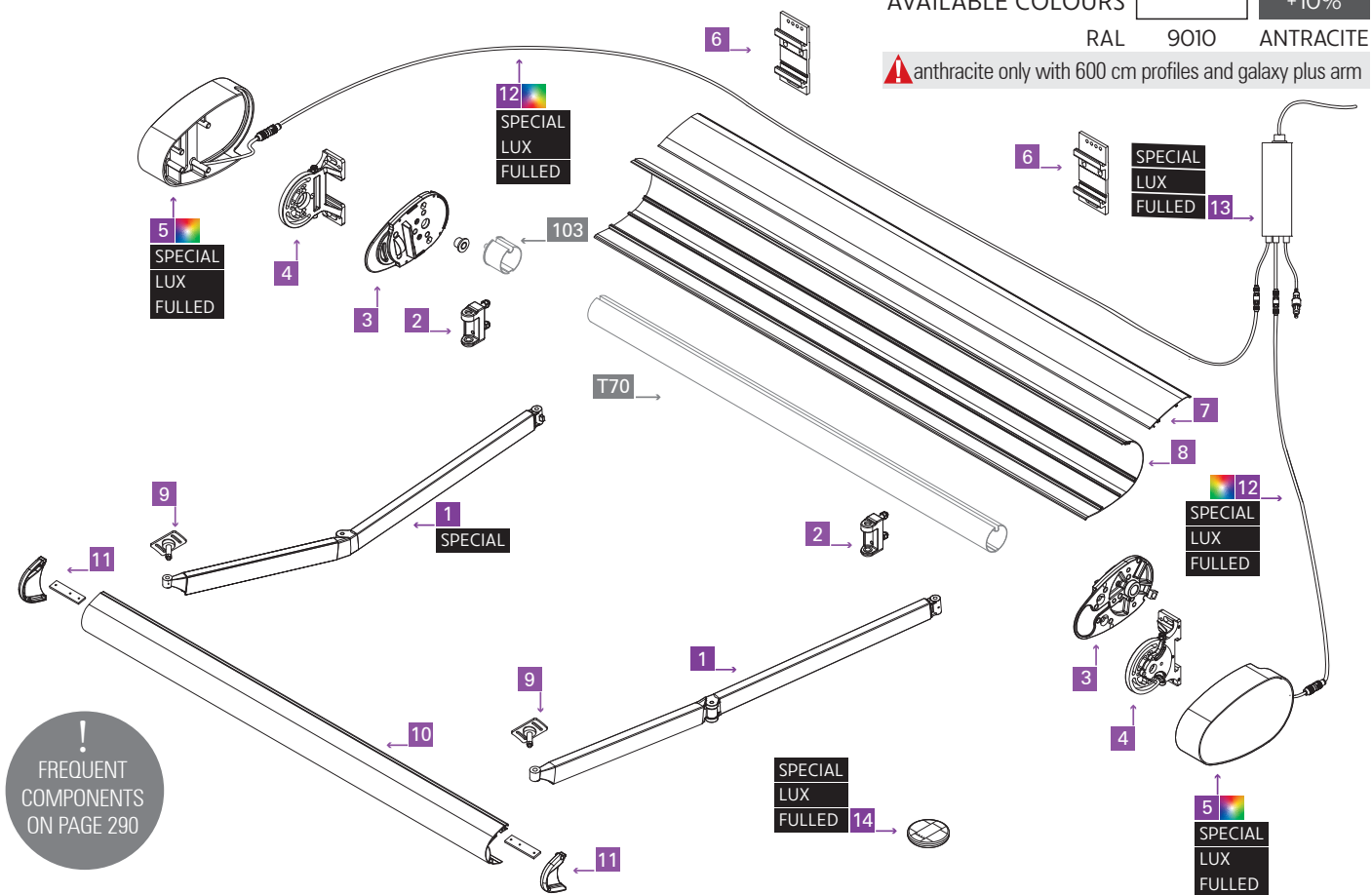

## LAYOUT FOR GIOTTO MILLENNIUM - SPECIAL

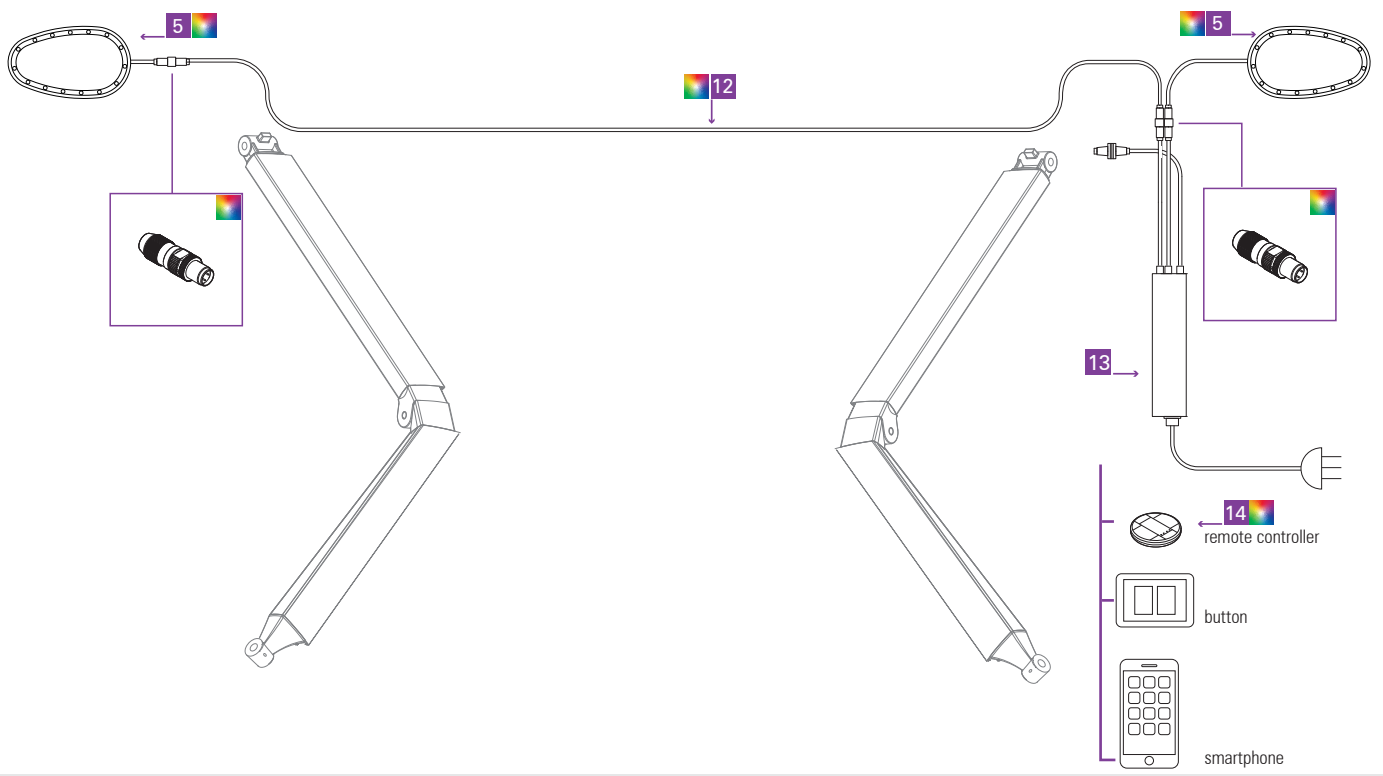

### GIOTTO MILLENNIUM - SPECIAL ABSORPTION CHART: WATTS

#### GIOTTO MILLENNIUM HEADER











absorption per piece

required power per piece

2,5 W/pc

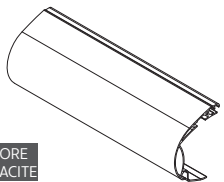
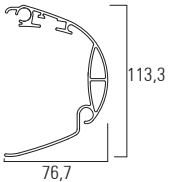
3 W/pc

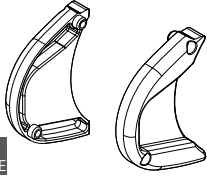
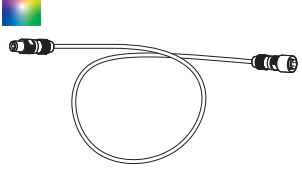
N°								
1			2XL150CAS 2XL175CAS 2XL200CAS 2XL225CAS 2XL250CAS 2XL275CAS 2XL300CAS 2XL325CAS 2XL350CAS	braccio cassiopea cassiopea arm Gelenkarm Cassiopea bras cassiopea brazo cassiopea braço cassiopea	150 cm 175 cm 200 cm 225 cm 250 cm 275 cm 300 cm 325 cm 350 cm	1 CP		
2			9XL604A	supporto braccio giotto h 55 giotto arm support h 55 Armträger Giotto h 55 support bras giotto h 55 soporte brazo giotto h 55 support braços giotto h 55	* 1 * 3	h 55	1 CP	
3			9XL602	supporto cassonetto giotto giotto cassette support Stützen für Giotto Kasette support coffre giotto soporte cajón giotto suporte caixote giotto			1 CP	
4			9XL603	supporto di regolazione cassonetto giotto adjustable support for giotto cassette Giotto-Kassette Einstellungsträger support de réglage pour coffre giotto soporte de regulación cajón giotto suporte de regulación caixote giotto			1 CP	
5			9XL600MNTCRGB  SPECIAL LUX FULL LED	testata giotto millennium RGB giotto millennium RGB header Kopfstoß Giotto Millennium RGB tête giotto millennium RGB cabecera giotto millennium RGB cabeçada giotto millennium RGB			1 CP	
6			9XL605	staffa parete/soffitto giotto giotto wall/ceiling bracket Wand/Deckenkonsole Giotto étrier de fixation plafond/mural giotto soporte pared/techo giotto estribo parede/teto giotto		9 cm	1 CP	
7			9XL600COPL4800 9XL600COPL6000 9XL600COPL7000	profilo cassonetto superiore giotto giotto cassette upper profile oberes Kassettenprofil Giotto profil supérieur coffre giotto perfil superior cajón giotto perfil superior caixote giotto		480 cm 600 cm 700 cm	1 PZ  2 PZ	
8			9XL600CASL4800 9XL600CASL6000 9XL600CASL7000	profilo cassonetto inferiore giotto giotto cassette lower profile unteres Kassettenprofil Giotto profil inférieur coffre giotto perfil inferior cajón giotto perfil inferior caixote giotto		480 cm 600 cm 700 cm	1 PZ  2 PZ	
9			9XL600DGA	prolunga giotto per bracci plus o galaxy giotto extension for plus arm or galaxy arms Giotto Ausleger für Plus - oder Galaxy - Arme rallonge giotto pour bras plus ou galaxy extensión giotto para brazos plus o sea galaxy extensão giotto de braço plus ou galaxy	* 3		1 CP	

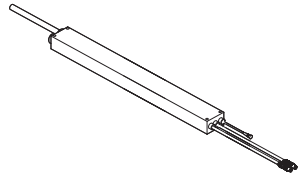
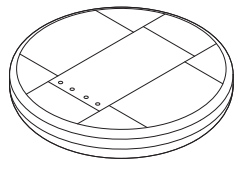
N°						
10	 COLORE ANTRACITE	9XL600TERL4800 9XL600TERL6000 9XL600TERL7000	profilo terminale giotto giotto terminal bar Giotto Ende-Ausfallprofil profil barre de charge giotto perfil barra de carga giotto perfil barra terminal giotto	 113,3 76,7	480 cm 600 cm 700 cm	1 PZ  2 PZ
11	 COLORE ANTRACITE	9XL600TAT	tappo terminale giotto giotto terminal bar end cover Deckel für Ende-Ausfallprofil Giotto bouchon barre de charge giotto tapa barra de carga giotto tampa barra terminal giotto			1 CP
12	 	PFCAPRORGB2 PFCAPRORGB4 PFCAPRORGB6 <b>SPECIAL</b> <b>LUX</b> <b>FULL LED</b>	cavo collegamento RGB RGB connection cable Verbindungskabel RGB câble de connexion RGB cable de conexión RGB cabo de conexão RGB		120 cm 400 cm 600 cm	1 PZ
13		PFALBOX2 <b>SPECIAL</b> <b>LUX</b> <b>FULL LED</b>	power supply RGB + dimmer 250W IP65 con pulsante/radio/wifi power supply RGB + dimmer 250W IP65 with button/radio/wifi power supply RGB + dimmer 250W IP65 mit Taste/Funk/Wifi power supply RGB + dimmer 250W IP65 avec touche/radio/wifi power supply RGB + dimmer 250W IP65 con botón/radio/wifi power supply RGB + dimmer 250W com botão/rádio/wifi			1 PZ
14		PFTELRGB <b>SPECIAL</b> <b>LUX</b> <b>FULL LED</b>	telecomando box RGB remote controller box RGB Fernlenkung box RGB télécommande box RGB telecomando box RGB control remoto box RGB			1 PZ

## OPTIONAL

optional disponibili per questa tenda  
extras available for this awning

vorhandene Möglichkeiten für diese Markise  
options disponibles pour ce store

opciones disponibles para este toldo  
opções disponíveis para este toldo

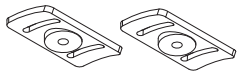
9B	 COLORE ANTRACITE	9XL600D	prolunga giotto giotto extension Verlängerung Giotto extension giotto prolongación giotto extensão giotto	*1		1 CP
----	---	---------	--	----	--	------



**KIT GIOTTO MILLENNIUM FOR MOTOR**

kit giotto millennium per motore  
giotto millennium kit for motor

kit Giotto Millennium für Motor  
kit giotto millennium pour moteur

kit giotto millennium para motor  
kit giotto millennium para motor

	<p><b>9XL600MH55MLN1</b></p>	<p>kit giotto millennium special per puntale pipetta giotto millennium special kit for pipette tip kit Giotto Millennium special für Pipetten-Spitze kit giotto millennium special pour embout à pipette kit giotto millennium special para punta en forma de pipeta kit giotto millennium special para ponta em forma de pipeta</p>	<p>*1</p>	<p>h 55</p>	<p>1 PZ</p>	<p>2 + 3 + 4 + 5 + 9B + 11</p>
	<p><b>9XL600MGXH55MLN1</b></p>	<p>kit giotto millennium special per bracci plus giotto millennium special kit for plus arms Kit Giotto Millennium special für Plus - Arme kit giotto millennium special pour bras plus kit giotto millennium special para brazos plus kit giotto millennium special de braços plus</p>	<p>*3</p>	<p>h 55</p>	<p>1 PZ</p>	<p>2 + 3 + 4 + 5 + 9 + 11</p>

**FOR ARMS \*1 \*3**

per braccio  
for arms

für Arme  
pour bras

para brazos  
por braço

\*1 ARIES - STAR - PEGASUS

\*3 GALAXY PLUS - ARIES PLUS - STAR PLUS - CASSIOPEA - CASSIOPEA LED

OPTIONAL ARM  
ALL ARM ON PAGE 212

GALAXY PLUS  
ARIES

ARIES PLUS  
STAR

STAR PLUS  
PEGASUS

PEGASUS PLUS  
CASSIOPEA LED



# GIOTTO MILLENNIUM - LUX

sporgenza max | max projection | maximale Ausladung  
avancée maximale | salida máx | saliência máxima

300 cm

AVAILABLE COLOURS  +10%  
RAL 9010 ANTRACITE

**!** anthracite only with 600 cm profiles and galaxy plus arm

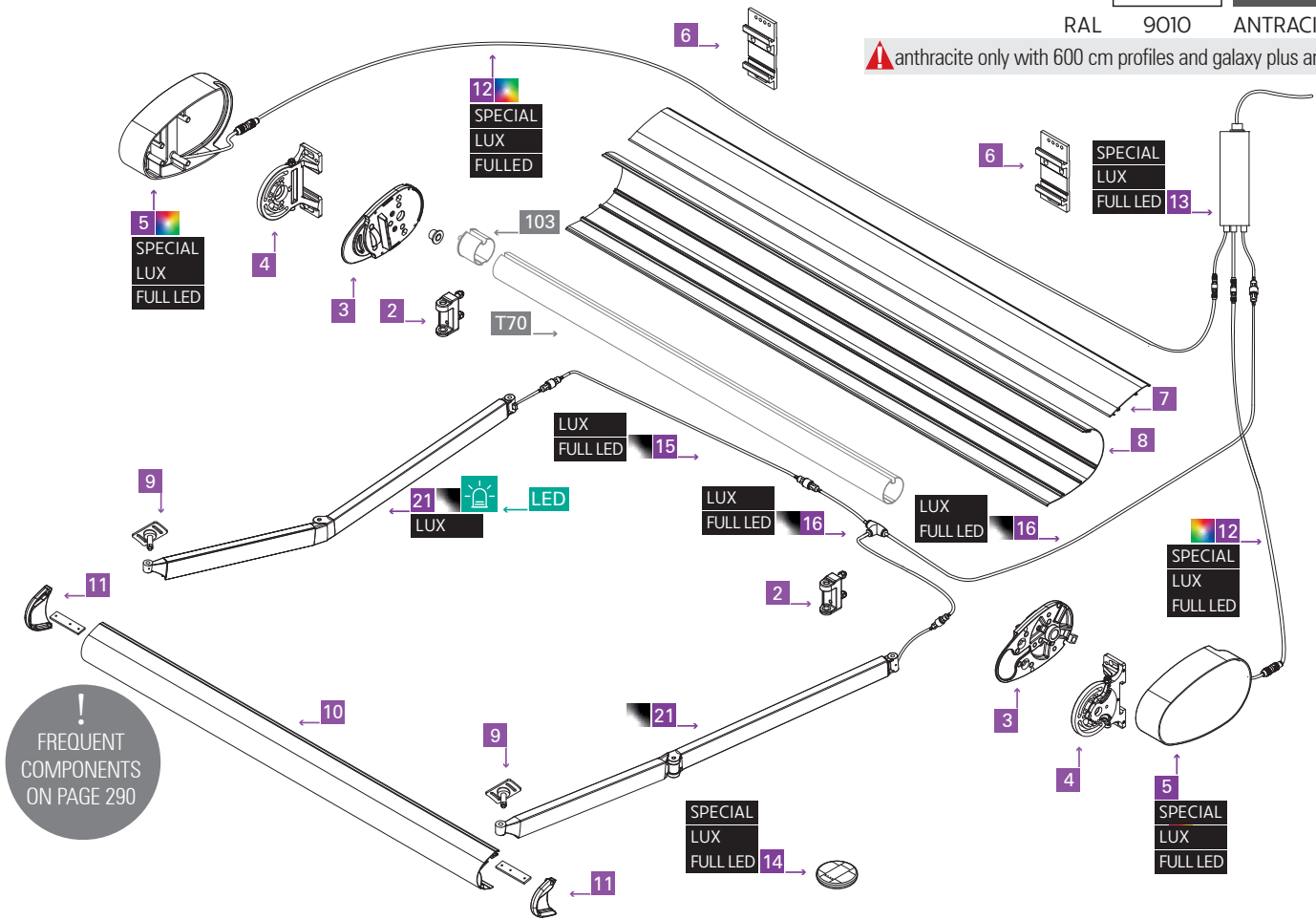

## LAYOUT FOR GIOTTO MILLENNIUM - LUX

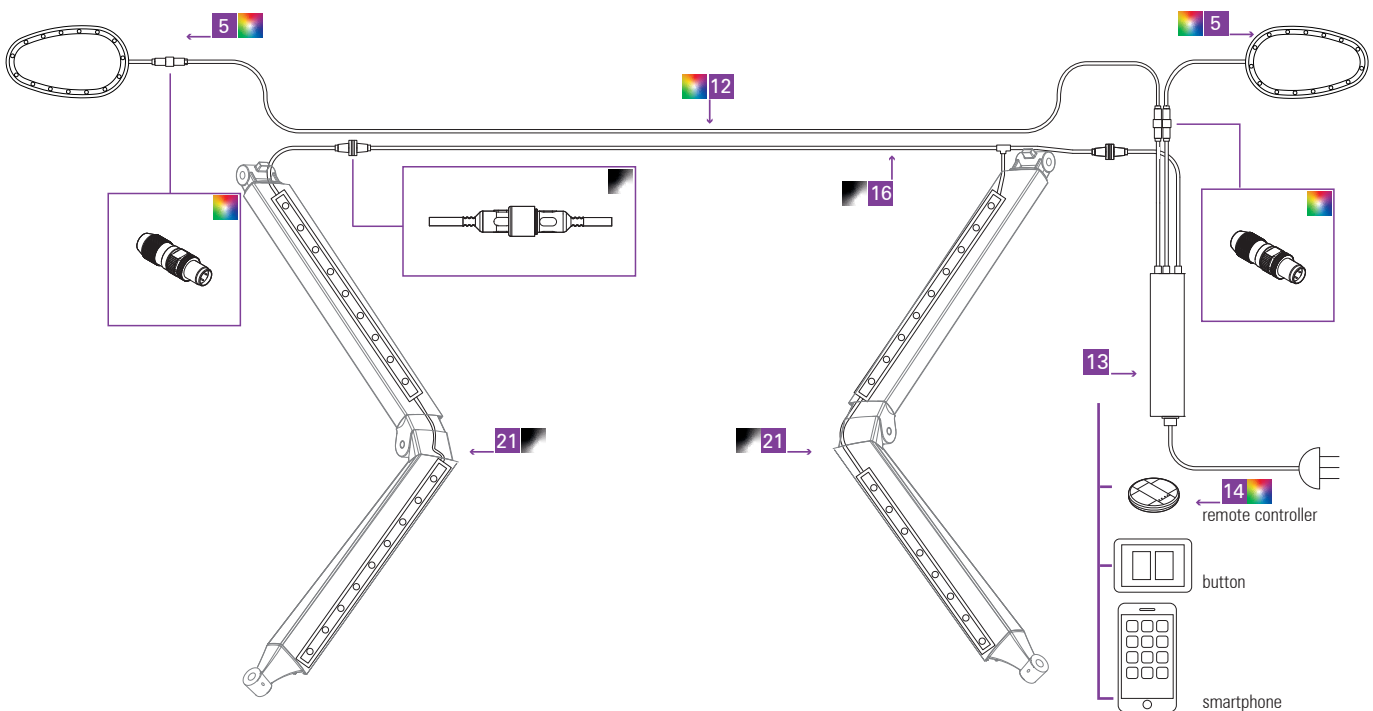

N° 











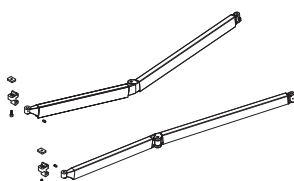

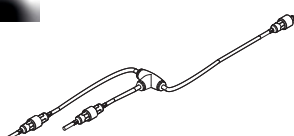
21		2XL150CASLD	braccio cassiopea led	150 cm	1 CP			
		2XL175CASLD	cassiopea led arm	175 cm				
LUX		2XL200CASLD	Gelenkarm Cassiopea led	200 cm				
		2XL225CASLD	bras cassiopea led	225 cm				
		2XL250CASLD	brazo cassiopea led	250 cm				
		2XL275CASLD	braço cassiopea led	275 cm				
		2XL300CASLD		300 cm				
		2XL325CASLD		325 cm				
		2XL350CASLD		350 cm				
		15		PFCVPROL5		cavo collegamento da 5 m 5 m connection cable Verbindungskabel 5 m Câble de connexion de 5 m Cable de conexión de 5 m Cabo de conexão de 5 m		1 PZ
				LUX				
		16		PFCVAULT		cavo collegamento a "T" 160/20/160 "T" connection cable 160/20/160 "T" Verbindungskabel 160/20/160 Câble de connexion en "T" 160/20/160 Cable de conexión "T" 160/20/160 Cabo de conexão "T" 160/20/160		1 PZ
LUX								
		FULL LED						

**KIT GIOTTO MILLENNIUM FOR MOTOR** 

kit giotto millennium per motore  
giotto millennium kit for motor

kit Giotto Millennium für Motor  
kit giotto millennium pour moteur

kit giotto millennium para motor  
kit giotto millennium para motor

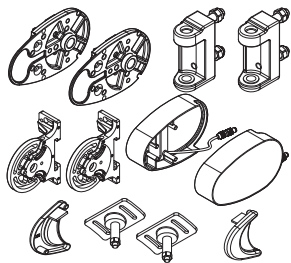

9XL600MGXH55MLN1



kit giotto millennium special per bracci plus  
giotto millennium special kit for plus arms  
Kit Giotto Millennium special für Plus - Arme  
kit giotto millennium special pour bras plus  
kit giotto millennium special para brazos plus  
kit giotto millennium special de braço plus

\*3 h 55 1 PZ

2 + 3 + 4 + 5 + 9 + 11

**HOW TO ASSEMBLE GIOTTO MILLENNIUM LUX**

COME ASSEMBLARE GIOTTO MILLENNIUM - LUX: comporre la versione SPECIAL, cambiare il braccio e aggiungere questi componenti.

COMMENT ASSEMBLER GIOTTO MILLENNIUM - LUX: composer la version SPECIAL, modifier le bras et ajoutent ces composants.

HOW TO ASSEMBLE GIOTTO MILLENNIUM - LUX: make up the SPECIAL version, change the arm and add these components

CÓMO MONTAR GIOTTO MILLENNIUM - LUX: hacer la versión SPECIAL, cambiar el brazo y añadir estos componentes

WIE MAN ZUSAMMENBAUT GIOTTO MILLENNIUM - LUX: die SPECIAL-Version zu erstellen, den Gelenkarm zu ändern und diese Komponenten hinzuzufügen.

COMO MONTAR GIOTTO MILLENNIUM - LUX: comporre la versione SPECIAL, cambiare il braccio e aggiungere questi componenti.

**GIOTTO MILLENNIUM - LUX ABSORPTION CHART: WATTS**

**WHITE FOR ARMS**

**GIOTTO MILLENNIUM HEADER**

absorption per meter

required power per meter

absorption per piece

required power per piece

see on page 300

see on page 300

2,5 W/pc

3 W/pc



# GIOTTO MILLENNIUM - FULL LED

sporgenza max | max projection | maximale Ausladung  
avancée maximale | salida máx | saliência máxima

300 cm

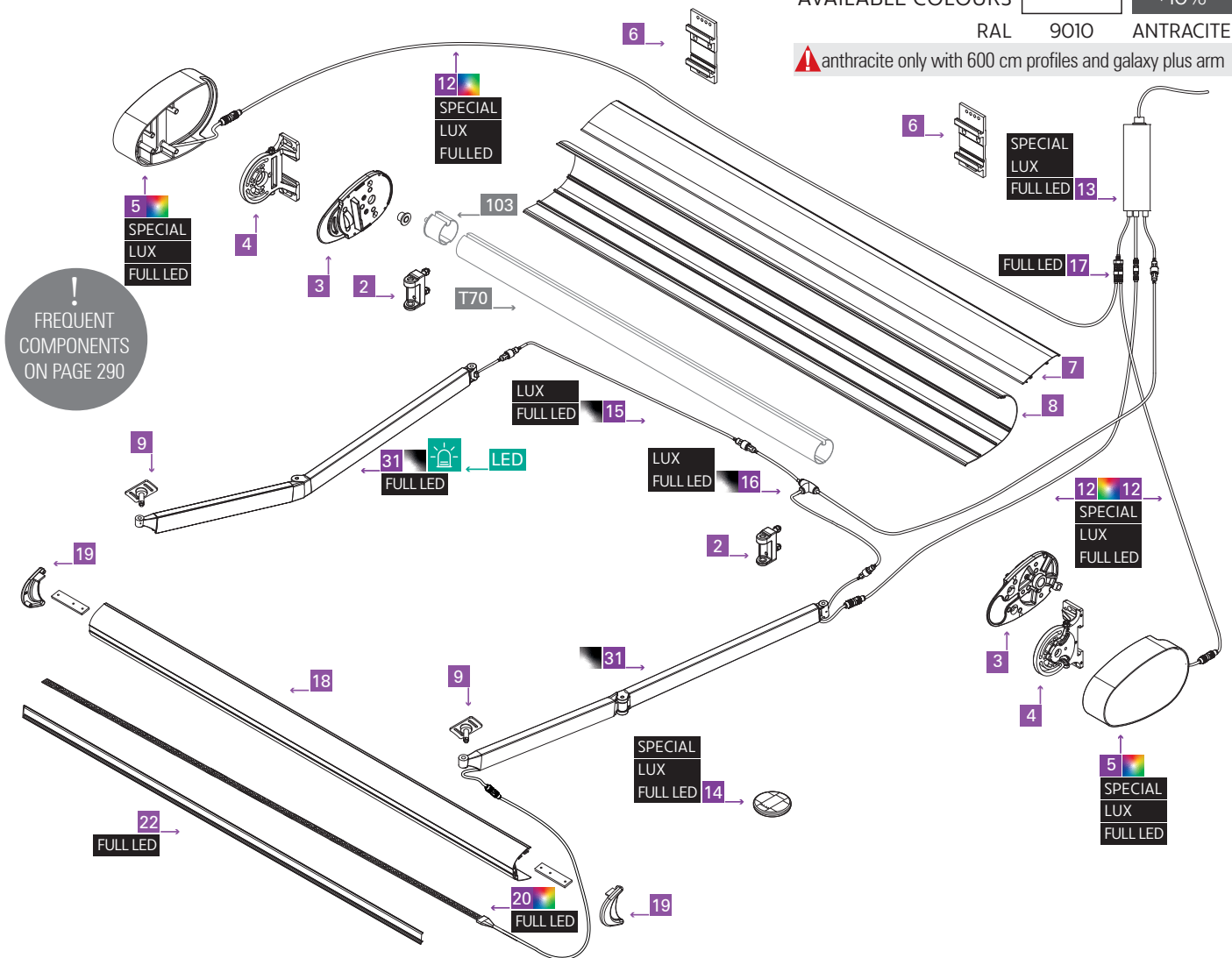

AVAILABLE COLOURS  +10%  
RAL 9010 ANTRACITE

anthracite only with 600 cm profiles and galaxy plus arm

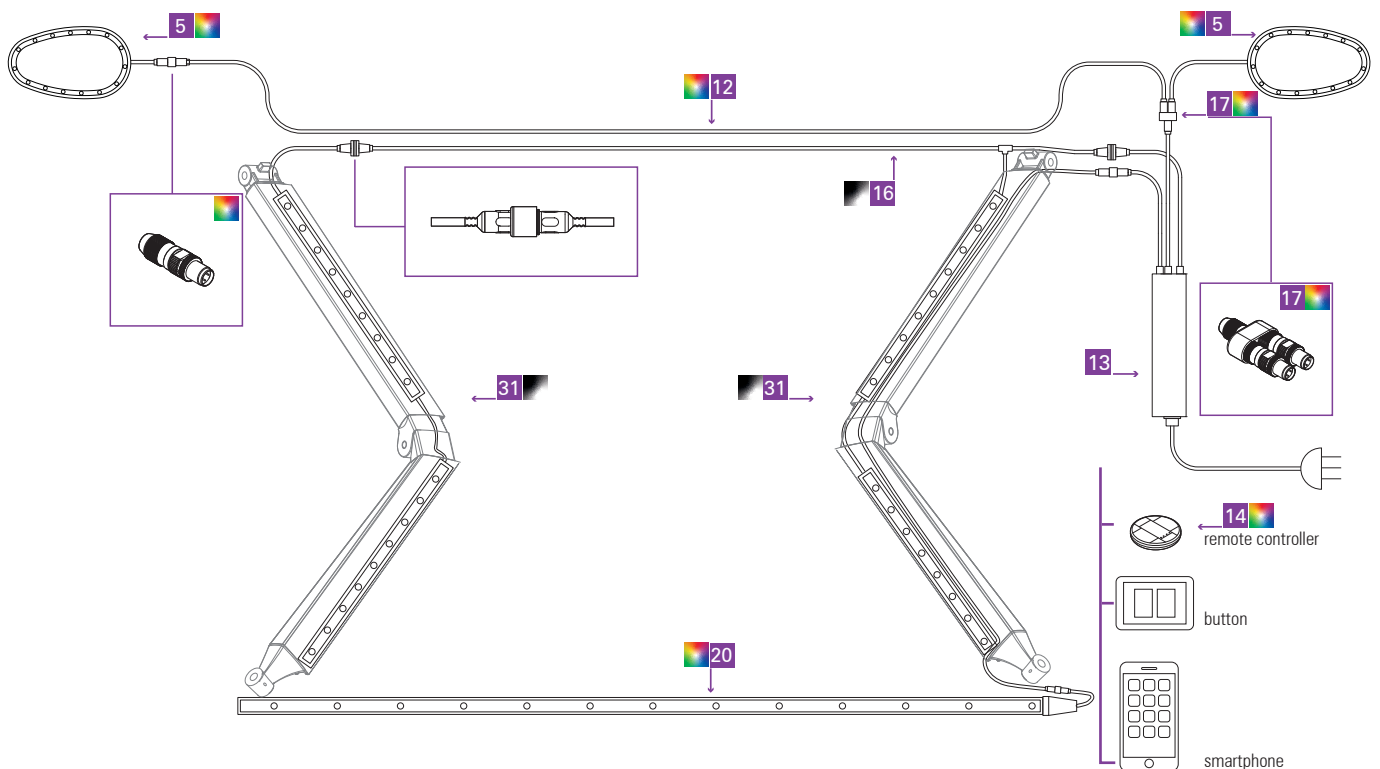

## LAYOUT FOR GIOTTO MILLENNIUM - FULL LED

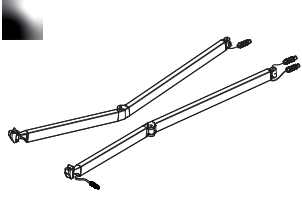
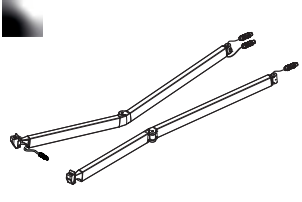
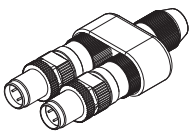
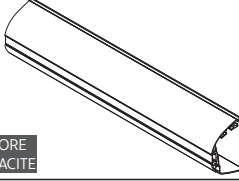
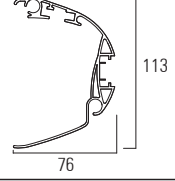
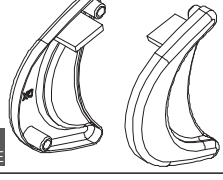
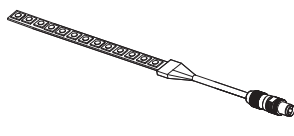
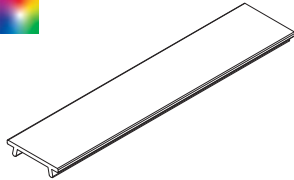

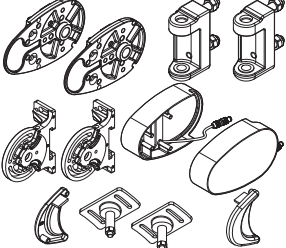
N°						
31		2XL150CASCBDX 2XL175CASCBDX 2XL200CASCBDX 2XL225CASCBDX 2XL250CASCBDX 2XL275CASCBDX 2XL300CASCBDX	<b>RIGHT ARM</b> braccio cassiopea led con cavo di alimentazione al terminale destro led cassiopea arm with power cable to right terminal Led Cassiopea Gelenkarm mit Stromkabel zum Terminal Rechts bras cassiopée avec câble d'alimentation vers le terminal droit brazo cassiopea led con cable de alimentación a terminal derecho braço cassiopea led com cabo de alimentação para terminal direito	150 cm 175 cm 200 cm 225 cm 250 cm 275 cm 300 cm	1 CP	
31		2XL150CASCBSX 2XL175CASCBSX 2XL200CASCBSX 2XL225CASCBSX 2XL250CASCBSX 2XL275CASCBSX 2XL300CASCBSX	<b>LEFT ARM</b> braccio cassiopea led con cavo di alimentazione al terminale sinistro led cassiopea arm with power cable to left terminal Led Cassiopea Gelenkarm mit Stromkabel zum Terminal Links bras cassiopée avec câble d'alimentation vers le terminal gauche brazo cassiopea led con cable de alimentación a terminal izquierdo braço cassiopea led com cabo de alimentação para terminal esquerdo	150 cm 175 cm 200 cm 225 cm 250 cm 275 cm 300 cm	1 CP	
17		PFSDRGB <b>FULL LED</b>	sdoppiatore cavo RGB RGB Cable splitter RGB Kabelsplitter RGB Répartiteur de câbles divisor de cable RGB RGB separador de cabos		1 PZ	
18	 COLORE ANTRACITE	9XL600MNTERL480 9XL600MNTERL600 9XL600MNTERL700 <b>FULL LED</b>	profilo terminale giotto millennium giotto millennium terminal bar Giotto Millennium Ende-Ausfallprofil profil barre de charge giotto millennium perfil barra de carga giotto millennium perfil barra terminal giotto millennium		480 cm 600 cm 700 cm	1 PZ 2 PZ
19	 COLORE ANTRACITE	9XL600MNTAT <b>FULL LED</b>	tappo terminale giotto millennium giotto millennium terminal bar end cover Deckel für Ende-Ausfallprofil Giotto Millennium bouchon barre de charge giotto millennium tapa barra de carga giotto millennium tampa barra terminal giotto millennium		1 CP	
20		PFRGBL6000 <b>FULL LED</b>	strip LED RGB - L. 600 cm led RGB strip length 600 cm Led RGB Streifen Länge 600 cm led RGB strip longueur 600 cm led RGB strip largo 600 cm led RGB strip extensão 600 cm		600 cm	1 PZ
22		ESTROPAL <b>FULL LED</b>	profilo oppale per led opalescent cover for LED opaleszierende Abdeckung für LED recouvrement opalescente pour LED cubierta opalescente para LED cobertura opalescente para LED			1 ML
		9XL600MGXH55MLN <b>FULL LED</b>	kit giotto millennium full led per bracci plus giotto millennium full led kit for plus arms Kit Giotto Millennium full led für Plus - Arme kit giotto millennium full led pour bras plus kit giotto millennium full led para brazos plus kit giotto millennium full led de braços plus	<b>* 3</b>	h 55	1 PZ
2 + 3 + 4 + 5 + 9 + 19						

GIOTTO MILLENNIUM - FULL LED ABSORPTION CHART: WATTS

LED RGB STRIP		WHITE FOR ARMS		GIOTTO MILLENNIUM HEADER	
absorption per meter	required power per meter	absorption per meter	required power per meter	absorption per piece	required power per piece
14,4 W/m	17,5 W/m	see on page 300	see on page 300	2,5 W/pc	3 W/pc

## HOW TO ASSEMBLE GIOTTO MILLENNIUM - FULL LED

### COME ASSEMBLARE GIOTTO MILLENNIUM - FULL LED:

comporre la versione LUX, cambiare il braccio, scegliendo con cura se destro o sinistro e aggiungere questi componenti. Attenzione a cambiare anche il profilo terminale e i tappi terminale.

### HOW TO ASSEMBLE GIOTTO MILLENNIUM - FULL LED:

make up the LUX version, change the arm, choosing carefully if right or left, and add these components. Attention to change the terminal bar and the terminal bar end caps.

### WIE MAN ZUSAMMENBAUT GIOTTO MILLENNIUM - FULL LED:

die LUX-Version zusammensetzen, den Gelenkarm zu ändern, sorgfältig zu wählen, ob rechts oder links, und diese Komponenten hinzuzufügen. Achten Sie darauf, das Ende-Ausfallprofil zu wechseln und die Deckel für Ende-Ausfallprofil.

### COMMENT ASSEMBLER GIOTTO MILLENNIUM - FULL LED:

composer la version LUX, changez le bras, en choisissant avec précaution si droite ou gauche, et ajoutez ces composants. Attention à changer également le profil barre de charge et les bouchons barre de charge.

### CÓMO MONTAR GIOTTO MILLENNIUM - FULL LED:

componga la versión LUX, cambie el brazo, eligiendo cuidadosamente si derecho o izquierdo, y añada estos componentes. Atención a cambiar también el perfil barra de carga y las tapas barra de carga.

### COMO MONTAR GIOTTO MILLENNIUM - FULL LED:

para compor a versão LUX, mudar o braço, escolhendo cuidadosamente se é direito ou esquerdo, e acrescentar estes componentes. Atenção para alterar também o perfil barra terminal e as tampas barra terminal.