

# PEGASUS PLUS



sporgenza max | max projection | maximale Ausladung  
avancée maximale | salida máx | saliência máxima

350 cm

arm  
projection



- 150 cm
- 175 cm
- 200 cm
- 225 cm
- 250 cm
- 275 cm
- 300 cm
- 325 cm
- 350 cm

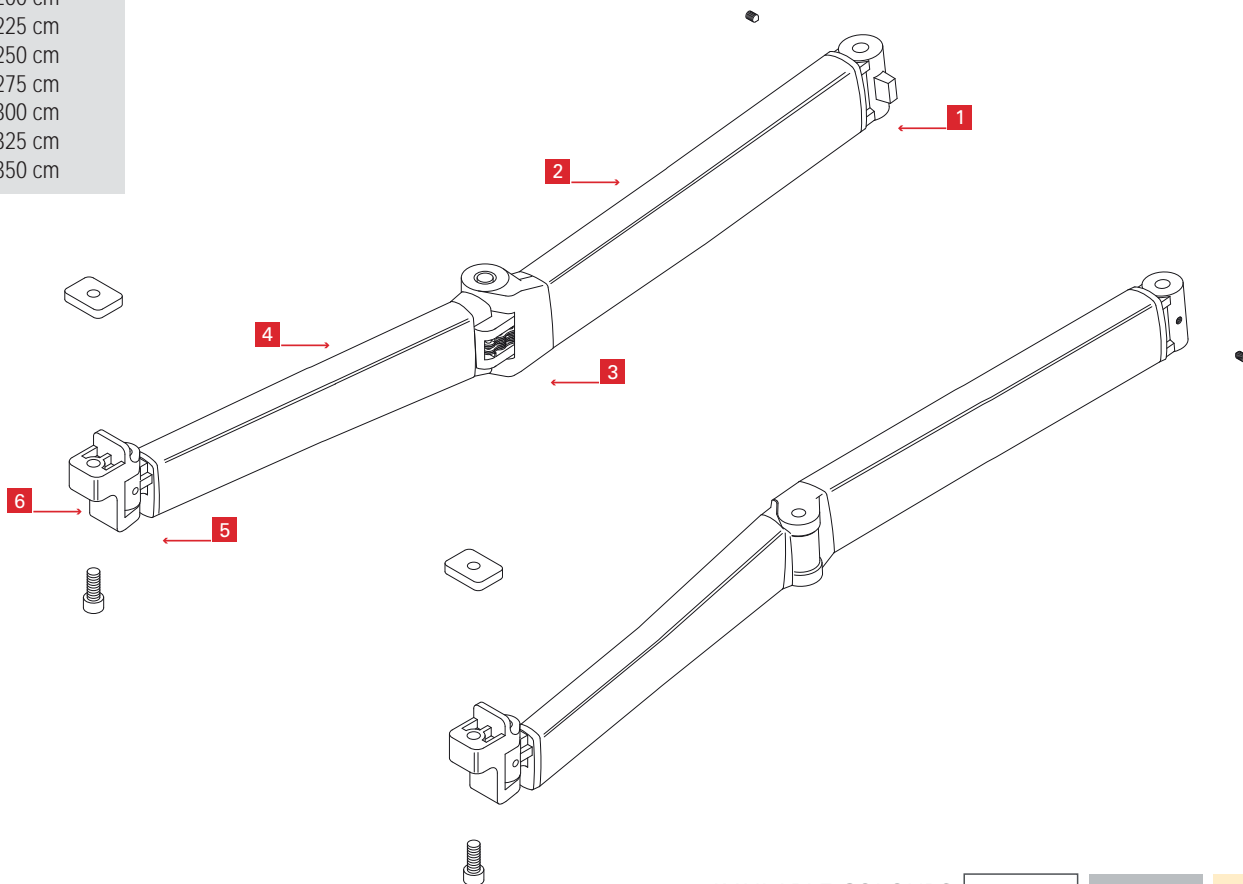

AVAILABLE COLOURS

RAL



9010



7035



1013

## AVAILABLE FOR AWNING

disponibile per tenda  
available for awning

RAFFAELLO  
MODIGLIANI  
BALLA  
TIZIANO  
DE CHIRICO

Erhältlich für folgende Markisen  
disponible pour store

TIEPOLO  
RENOIR  
GIORGIONE  
PERUGINO

disponibile para toldo  
disponibilidade por toldo

GIOTTO

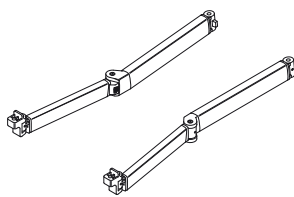

2XL150  
2XL175  
2XL200  
2XL225  
2XL250  
2XL275  
2XL300  
2XL325  
2XL350



braccio pegasus plus  
pegasus plus arm  
Gelenkarm Pegasus Plus  
bras pegasus plus  
brazo pegasus plus  
braço pegasus plus









150 cm  
175 cm  
200 cm  
225 cm  
250 cm  
275 cm  
300 cm  
325 cm  
350 cm



1 CP



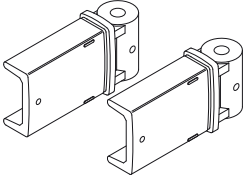
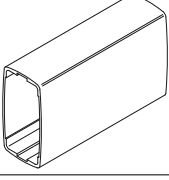
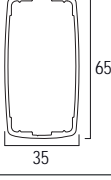
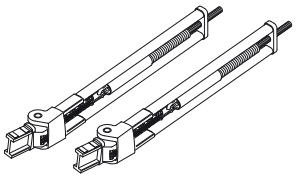
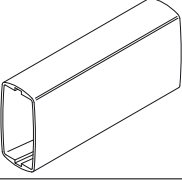
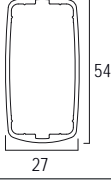
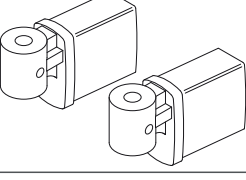
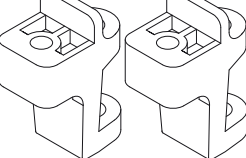

N°						
1		2XL900B	spalla standard standard abutment Standard Leibung épaule standard hombro standard hombro standard		1 CP	
2		EXSD02L7000	profilo superiore standard standard upper profile Standard Oberprofil profil supérieur standard perfil superior standard perfil superior standard		700 cm	1 PZ
3		2XL907B 2XL907C 2XL907E 2XL907D	cartuccia pegasus pegasus cartridge Pegasus-Kartusche cartouche pegasus cartucho pegasus cartucho pegasus		150-225 250-275 300-325 350 cm	1 CP
4		EXMGSD01L7000	profilo inferiore standard standard lower profile Standard Unterprofil profil inférieur standard perfil inferiorstandard perfil inferior standard		700 cm	1 PZ
5		2XL900C	puntale standard standard tip Standard Spitze pointe standard punta standard ponteira standard		1 CP	
6		2XL900D	prolunga standard standard extension Standard Verlängerung prolonge standard prolongación standard extensão standard		1 CP	

**OPTIONAL**

optional disponibili per questo braccio  
extras available for this arm type

vorhandene Möglichkeiten für diesen Arm  
options disponibles pour ce bras

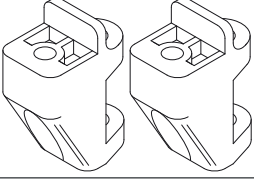
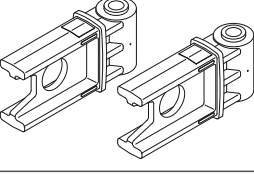
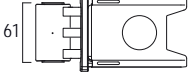
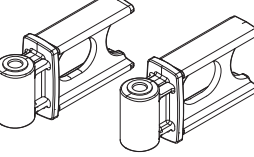
opciones disponibles para este brazo  
opções disponíveis para este braço

	2XL900DST	prolunga star star extension Star Verlängerung prolonge star prolongación star extensão star			1 CP	
	2XL900BDV	spalla standard maggiorata standard bigger abutment Standard Vergrößerte Leibung épaule standard majoré hombro standard aumentado hombro standart aumentado			1 CP	
	2XL9000M	spalla om om abutment Leibung Om épaule om hombro om hombro om			1 CP	