

DA VINCI COVER

sporgenza max | max projection | maximale Ausladung
avancée maximale | salida máx | saliência máxima

600 cm





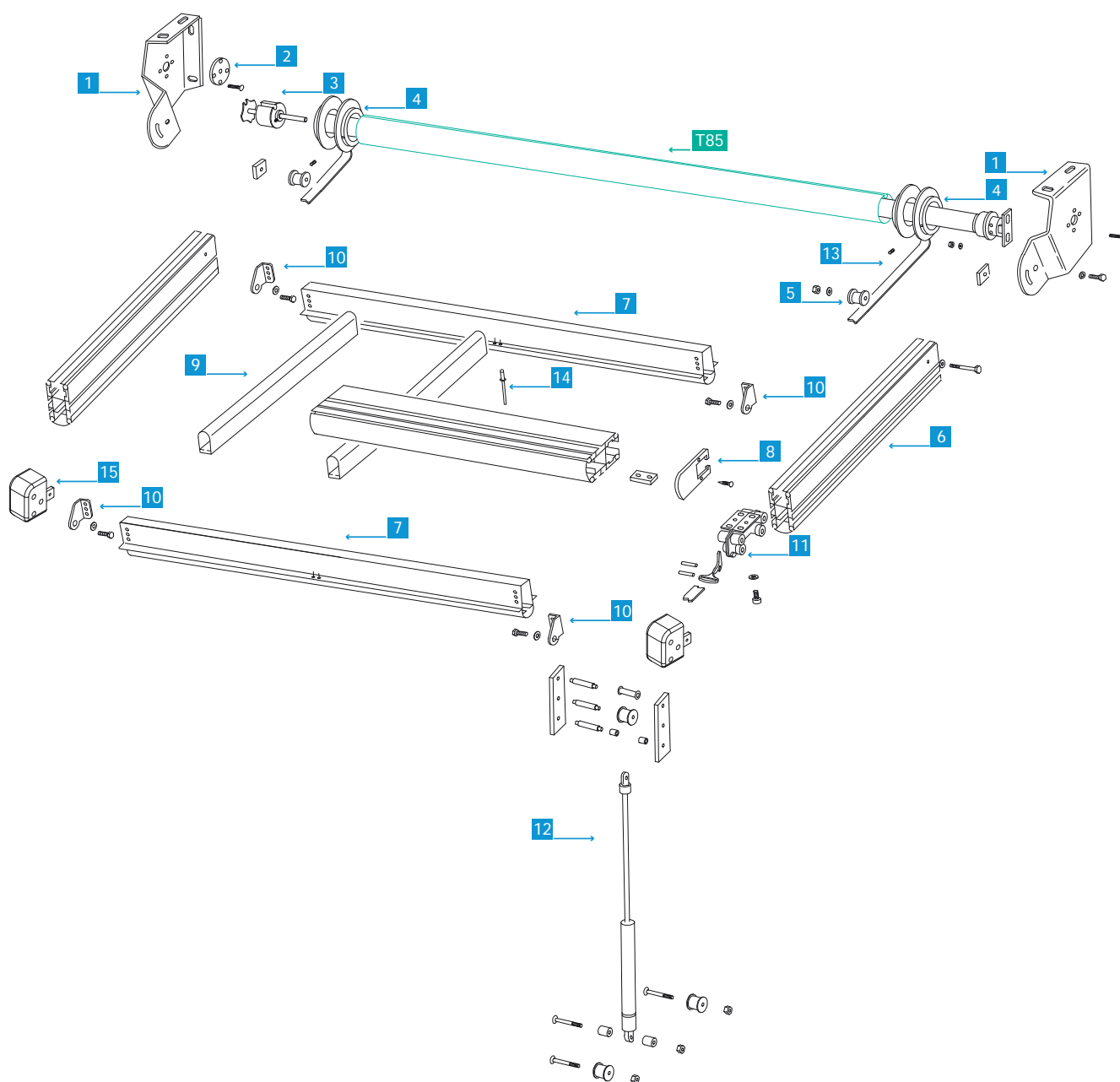











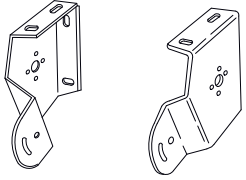

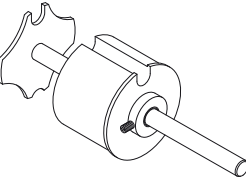
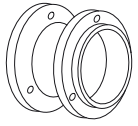
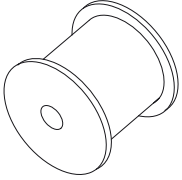
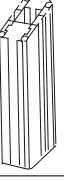
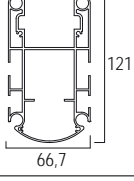
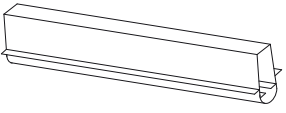
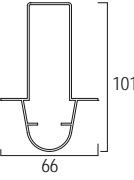
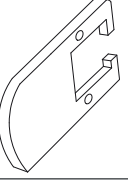
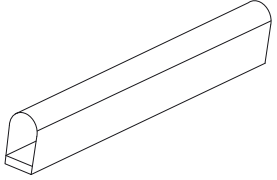
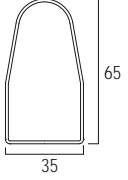
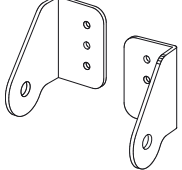

!
FREQUENT
COMPONENTS
ON PAGE 248

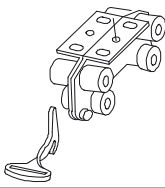

AVAILABLE COLOURS

RAL 9010

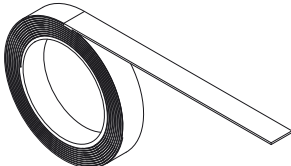
N°						
1		14XLWSLMO	<p>staffa laterale da vinci da vinci lateral bracket Seitenklammer zur Da Vinci Markise étrier latéral pour da vinci soporte lateral del da vinci estribo lateral da vinci</p>		1 CP	
2		14XLWBOAC	<p>boccola in acetilica Ø 12x70 Ø 12x70 acetalic bushes Acetal-Hülse Ø 12x70 douille acétal Ø 12x70 buje de acetálica Ø 12x70 acetal bucha Ø 12x70</p>		1 PZ	
3		15XLCPT85	<p>calotta in alluminio 85 Ø perno tondo regolabile 85 Ø Aluminium cap with adjustable round pin einstellbarer Aluminiumdeckel Ø 85 Rundstift calotte en aluminium 85 Ø pivot rond réglable tapa de aluminio Ø 85 pines redondo regulable tampa de aluminio Ø 85 pino redondo ajustável</p>		1 PZ	
4		14XLWGH85	<p>ghiere Ø 85 per guida cinghia 85 Ø threaded nut for belt guide Ringe Ø 85 für Riemen-Führung embout Ø 85 pour guide sangle anillos Ø 85 para guía de correa mostradores Ø 85 para condução de correa</p>		1 CP	
5		14XLWRINCI	<p>rullo rinvio cinghia belt pulley Walze für Riemen-Rückkehr rouleau de renvoi sangle rodillo correa de transmisión transmissão da correa rolo</p>		1 PZ	
6		14XLWGUIL5000 14XLWGUIL6000 14XLWGUIL7000	<p>guida e terminale da vinci da vinci guide and terminal profile Da Vinci Führung und Ende-Ausfallprofil guide et barre de charge da vinci guía y terminal da vinci guia e terminal da vinci</p>		500 cm 600 cm 700 cm	1 PZ
7		14XLWFRTRL4650 14XLWFRTRL5750 14XLWFRTRL7000	<p>frangitratta trasversale da vinci da vinci transverse windbreake durchquerender Windschott Da Vinci brise-vent transversal da vinci cortavientos transversal da vinci disjuntor cruzado da vinci</p>		465 cm 575 cm 700 cm	1 PZ
8		14XLWTAFRO	<p>tappo frontale da vinci da vinci front cap Da Vinci Vorder-Deckel bouchon frontal da vinci capuchón frontal da vinci tampa frontal da vinci</p>		1 PZ	
9		14XLWFRVEL5000 14XLWFRVEL7000	<p>frangitratta verticale da vinci da vinci vertical windbreake vertikaler Windschott Da Vinci brise-vent vertical da vinci cortavientos vertical da vinci disjuntor verticais da vinci</p>		500 cm 700 cm	1 PZ
10		14XLWSPROL	<p>supporto profilo laterale da vinci da vinci lateral profile support Da Vinci-Seitenprofilsstütz support profil latéral da vinci soporte perfil lateral Da Vinci apoio perfil lateral da vinci</p>		1 CP	

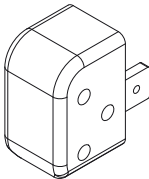
N°						
11		14XLWCARR	carrello di scorrimento da vinci da vinci sliding trolley Gleitschlitten Da Vinci chariot à roulement da vinci carro de deslizamiento da vinci carrinho de rolagem da vinci		1 PZ	
12		14XLWMOGA80 14XLWMOGA105	gruppo molla a gas gas spring with components Gasfeder-Gruppe ressort à gaz avec composants grupo resorte de gas grupo mola a gás	80 cm 105 cm	1 PZ	
13		14XLWCIN	cinghia per da vinci 20x0,9 20x0.9 belt for da vinci Da Vinci Riemen 20x0,9 sangle pour da vinci 20x0,9 correa para da vinci 20x0,9 correia da vinci 20x0,9		1 ML	
14		14XLRIVET	rivetto 4,8x10 4.8x10 rivet Niete 4,8x10 rivet 4,8x10 remache 4,8x10 rebite 4,8x10		1 PZ	
15		14XLWRIN	rinvio copertura da vinci return for coverage da vinci Verlegung für Da Vinci Deckung renvoi couverture da vinci pieza para cobertura da vinci pieza para cobertura da vinci		1 PZ	