

CALLAS ZIP

larghezza max | max width cm | Max. Breite cm
 largeur max cm | ancho máx cm | largura max cm

450 cm



altezza max | max height | maximale Höhe
 hauteur max | salda máx | saliência máxima

300 cm

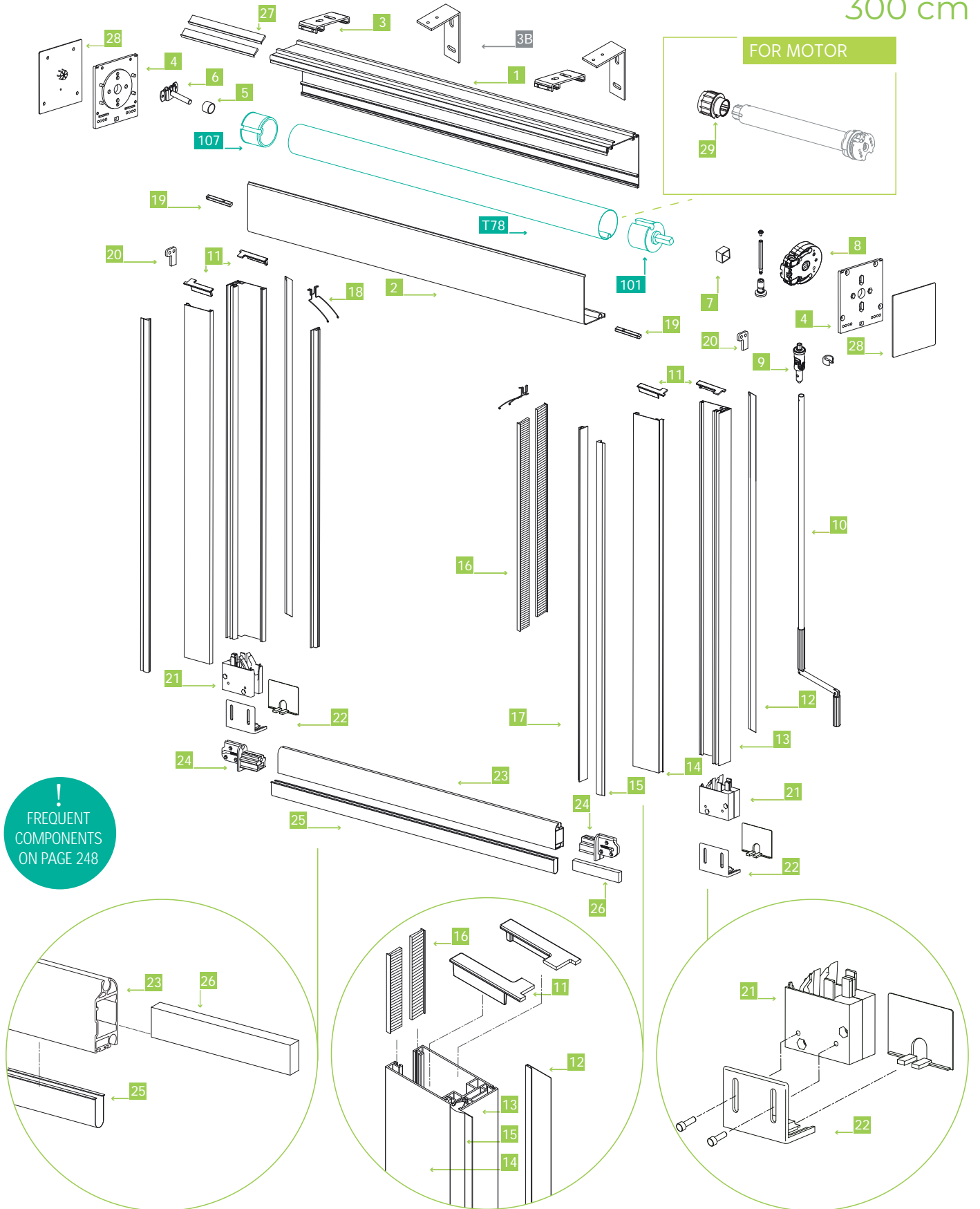



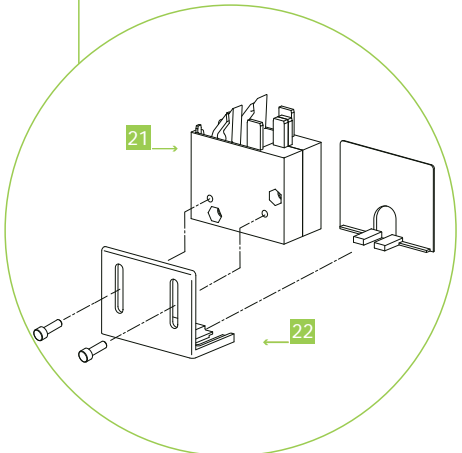
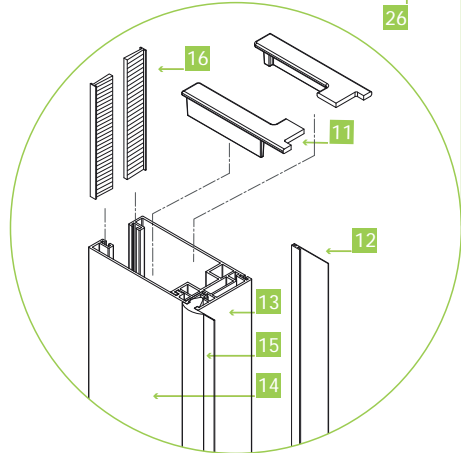
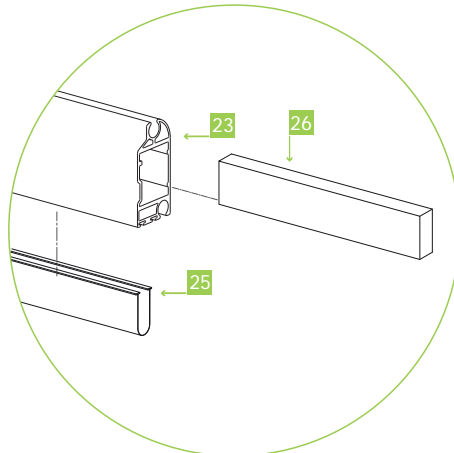









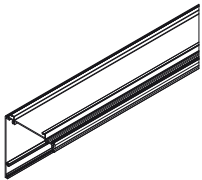
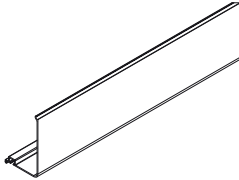
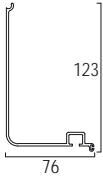
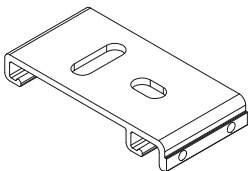
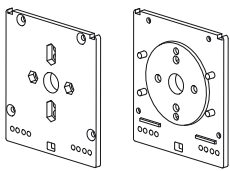
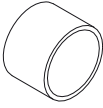
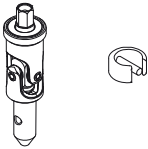
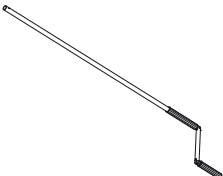



!
 FREQUENT
 COMPONENTS
 ON PAGE 248



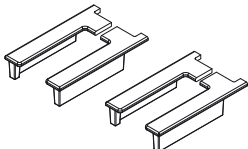
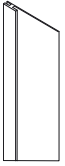

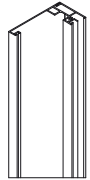
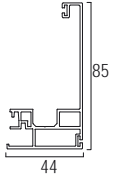
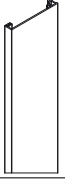

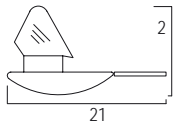
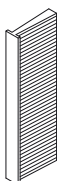

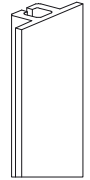
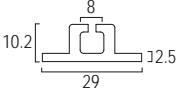
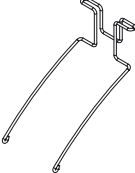
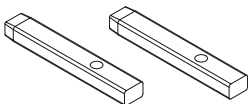
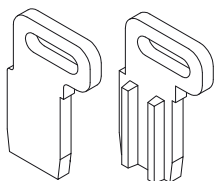



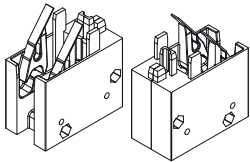
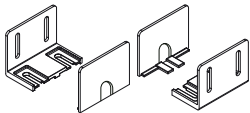
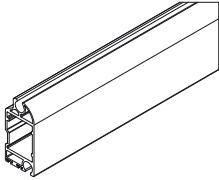
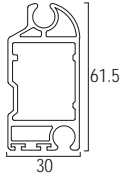
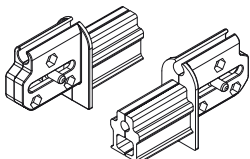
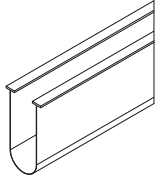
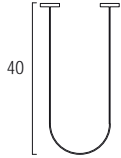

AVAILABLE COLOURS

RAL 9010	7035	1013	+10% ANTRACITE	8017

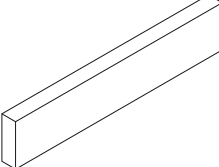
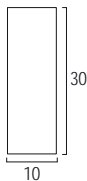
N°						
1		10XLEKASFIL4500 10XLEKASFIL6000	<p>cassonetto fisso callas</p> <p>callas fixed cassette profile</p> <p>Kassettenprofil Callas</p> <p>profil coffre fixe callas</p> <p>perfil cajón fijo callas</p> <p>perfil caixote fixo callas</p>		450 cm 600 cm	1 PZ 
2		10XLEKCASTEL4500 10XLEKCASTEL6000	<p>cassonetto apribile callas</p> <p>callas opening cassette profile</p> <p>Kassettenprofil Callas zu öffnen</p> <p>profil coffre ouvrant callas</p> <p>perfil cajón móvil callas</p> <p>caixote que pode ser aberto callas</p>		450 cm 600 cm	1 PZ 
3		10XLEKSTASOF	<p>staffa soffitto callas</p> <p>callas ceiling bracket</p> <p>Deckenkonsole Callas</p> <p>étrier de fixation plafond callas</p> <p>soporte al techo callas</p> <p>estribo teto callas</p>			1 PZ
4		10XLEKTES12	<p>testata callas h 12</p> <p>header callas h 12</p> <p>Kopfstoß Callas h 12</p> <p>tête callas h 12</p> <p>cabeçera callas h 12</p> <p>cabeçada callas h 12</p>		h 12	1 CP
5		10XLEKDITO	<p>distanziatore tondo per calotta</p> <p>round spacer for cap</p> <p>Abstand Rundprofil (für Wellenkapsel)</p> <p>espaceur rond pour calotte</p> <p>espesor redondo para máquina sinfin</p> <p>espaçador redondo para tampa</p>			1 PZ
6		10XLEKPIVUNO	<p>pivot per calotta con foro tondo</p> <p>cap pin with round hole</p> <p>Plättchen mit Stift für Wellenkapsel. Rundloch</p> <p>pivot pour calotte avec trou rond</p> <p>perno por casquillo con agujero redondo</p> <p>pivô para calote com furo redondo</p>			1 PZ
7		10XLEKDIQU	<p>distanziatore quadro per arganello</p> <p>square spacer for reduction winch</p> <p>Abstand Quadratischeprofil (für Getriebe)</p> <p>espaceur carré pour treuil</p> <p>espesor cuadro para máquina sinfin</p> <p>espaçador quadrado para sarrilho</p>			1 PZ
8		10XLEKARIOSOT	<p>arganello 10/1 mm 25 + kit magnetico</p> <p>reduction winch 10/1 mm 25 + magnetic kit</p> <p>Getriebe 10/1 mm 25 + Magnetic Kit</p> <p>treuil 10/1 mm 25 + kit magnétique</p> <p>máquina sinfin 10/1 mm 25 + kit magnético</p> <p>sarrilho 10/1 mm 25 + kit magnético</p>			1 PZ
9		10XLEKMAGN	<p>kit magnetico per aggancio asta ad argano</p> <p>magnetic kit for crank rod's hook to winch</p> <p>Magnetische Verbindung Kurbel/Getriebe</p> <p>kit magnétique pour attacher la manivelle au treuil</p> <p>kit magnético para enganchar la manivela a la máquina sinfin</p> <p>kit magnético para enganchar haste ao sarrilho</p>			1 PZ
10		10XLEKASTA120 10XLEKASTA150 10XLEKASTA180	<p>asta ripiegabile</p> <p>folding crank rod</p> <p>Faltbare Kurbel</p> <p>manivelle pliable</p> <p>manivela plegable</p> <p>haste dobrável</p>		120 cm 150 cm 180 cm	1 PZ

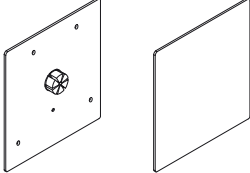
N°						
11		10XLEKTAPGU	<p>tappo superiore per profilo guida callas upper cap for callas guide profile Oberer Deckel für Callas Führung bouchon supérieur pour guide callas tapón superior para guía callas tampa superior para perfil guía callas</p>		1 CP	
12		10XLEKGUACP01	<p>guarnizione di chiusura closure gasket Gummidichtung joint de fermeture sello de goma de cierre guía junção de fechamento</p>		1 ML	
13		10XLEKGUL5600	<p>guida callas callas profile guide Führung Callas guide callas guía callas guia callas</p>		560 cm	1 PZ
14		10XLEKALGL5600	<p>aletta per guida callas callas fin for guide Verschlussprofil für Führung Callas fermeture de guide callas aleta por guía callas albeta para guia callas</p>		560 cm	1 PZ
15		10XLEKGUARL	<p>guarnizione per guida callas gasket for callas guide Dichtung für Callas Führung joint en PVC pour guide callas junta para guía callas junta de guía callas</p>			1 ML
16		10XLEKSPAZ	<p>spazzolino brush Bürste brosse cepillo escova</p>			1 ML
17		10XLEKGUZIP3000	<p>guida zip zip guide Zip Führung guide zip guía zip guia zip</p>		300 cm	1 PZ
18		10XLEKMOLZI	<p>molla per guida zip spring for zip guide Feder für Zip Führung ressort pour guide ZIP resorte para guía zip mola para guía zip</p>			1 PZ
19		10XLEKTPBC	<p>piastrina blocco cassonetto cassette profile lock plate Kassette Verriegelung plaquette de blocage profil coffre Plaquita de bloqueo perfil cajón móvil Chapinha de bloqueio de perfil de caixote</p>		1 CP	
20		10XLEKPIAS	<p>piastrina giunzione per testata joint plate for header Kupplung Plättchen für Kopfstoß plaquette de jonction de la Tête a la guide plaquita junta para cabecera chapinha de junção para cabeçote</p>		1 CP	

N°						
21		10XLEKPIE	<p>piede callas callas foot Bodenbefestigung Callas ped callas pie callas pé callas</p>		1 CP	
22		10XLEKCOPI	<p>copri piede callas foot cover callas Fußabdeckung Callas couvre-pied callas tape por pie callas capa de pé callas</p>		1 CP	
23		10XLEKTERL4500 10XLEKTERL6000	<p>terminale callas callas terminal bar Ende-Ausfallprofil Callas barre de charge callas barra de carga callas barra terminal callas</p>		450 cm 600 cm	1 PZ
24		10XLEKPUN	<p>puntale terminale callas callas terminal profile tip Halterungen für Callas Ausfallprofil pointe pour barre de charge callas punta para perfil terminal callas ponta de perfil terminal callas</p>		1 CP	
25		10XLEKGUAF01	<p>guarnizione morbida per profilo inferiore smooth gasket for lower profile Gummidichtung für Ausfallprofil Joint souple en PVC pour la barre de charge junta de goma para perfil inferior cajón junta mole para perfil inferior</p>			1 ML 100 ML 
26		10XLEKZAVL2000	<p>zavorra in ferro zincato 30x10 ballast in galvanized iron 30x10 Ballast aus verzinktem Eisen 30x10 lest en acier galvanisé 30x10 balasto en acero galvanizado 30x10 balastro em aço galvanizado 30x10</p>		200 cm	1 PZ
27		10XLEKGUACP03	<p>guarnizione di chiusura perpendicolare closure perpendicular gasket senkrechte Verschlussdichtung joint de fermeture perpendiculaire sello de goma de cierre guía pependicular guarnição de fechamento perpendicular</p>			1 ML 100 ML 
28		10XLEKTPTE12	<p>tappo testata callas header cup callas Deckel für Kopfstoß Callas bouchon tête callas Tapa cabecera callas Tampa cabeçada callas</p>		1 CP	

N° 

FOR MOTOR

per motore
for motormit Motor
avec moteurcon motor
com motor

29

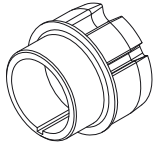

10XLEKCAL78

calotta per motore per tubo Ø 78
 cap for motor for Ø 78 tube
 MotorAdapter für Welle 78
 calotte pour le ZIP pour adapter le moteur au tube Ø 78
 casquillo por ZIP para adaptar el motor al tubo Ø 78
 adaptador para motor para tubo Ø 78

1 PZ

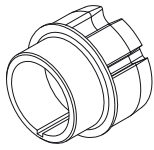

10XLEKCAL85

calotta per motore per tubo Ø 85
 cap for motor for Ø 85 tube
 MotorAdapter für Welle 85
 calotte pour le ZIP pour adapter le moteur au tube Ø 85
 casquillo por ZIP para adaptar el motor al tubo Ø 85
 adaptador para motor para tubo Ø 85

1 PZ

KIT CALLAS

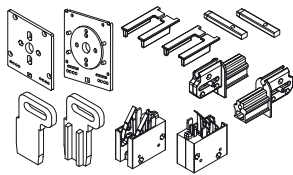
kit callas
callas kitCallasSet
kit callaskit callas
kit callas

10XLEKIT

kit callas
 callas kit
 CallasSet
 kit callas
 kit callas
 kit callas

4 + 11
 + 19 + 20
 + 21 + 24

1 PZ

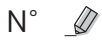





OPTIONAL

optional disponibili per questa tenda
extras available for this awning

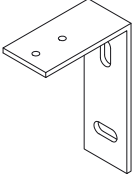
vorhandene Möglichkeiten für diese Markise
options disponibles pour ce store

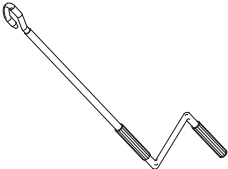
opciones disponibles para este toldo
opções disponíveis para este toldo

3B		10XLEKSTAPAR	staffa parete callas callas wall bracket Wandkonsole Callas étrier mur callas placa de fijación pared callas estribo parede callas		1 PZ
8B		PFARG11/1	arganello 11/1 reduction winch 11/1 Getriebe 11/1 treuil 11/1 máquina sinfín 11/1 sarilho 11/1		1 PZ
10B		PFASM120 PFASM150 PFASM180 PFASM200 PFASM220 PFASM250	asta manovra crank rod Bedienungsstange manivelle manivela manivela	120 cm 150 cm 180 cm 200 cm 220 cm 250 cm	1 PZ 

OPTIONAL Ø 85 ON PAGE 252

tubo avvolgitore, calotta in nylon perno quadro,
calotta in nylon con foro

Tuchwelle, Nylon-Wellenkapsel mit Vierkantstift,
Nylon-Wellenkapsel mit Loch

tubo de enrollle, casquillo de nylon perno cuadrado,
casquillo de nylon con agujero

roller tube, nylon cap with square pin, nylon cap
with hole

tube enrouleur, calotte en nylon pivot carré, calotte
en nylon avec trou

tubo enrolador, calote em nylon eixo quadrado,
calote em nylon com furo