



# FREQUENT COMPONENTS

componenti frequenti  
frequent components  
Häufige Zubehöre  
composants communs  
componentes comunes  
componentes comuns

## ROLLER TUBE, SQUARE BAR, JOINT

tubo avvolgitore, barra quadra, giunzione  
roller tube, square bar, joint

Tuchwelle, Vierkant-Tragrohr, Kupplung  
tube enrouleur, barre carrée, jonction

tubo de enrolle, barra cuadrada, junta  
tubo enrolador, barra quadrada, junção

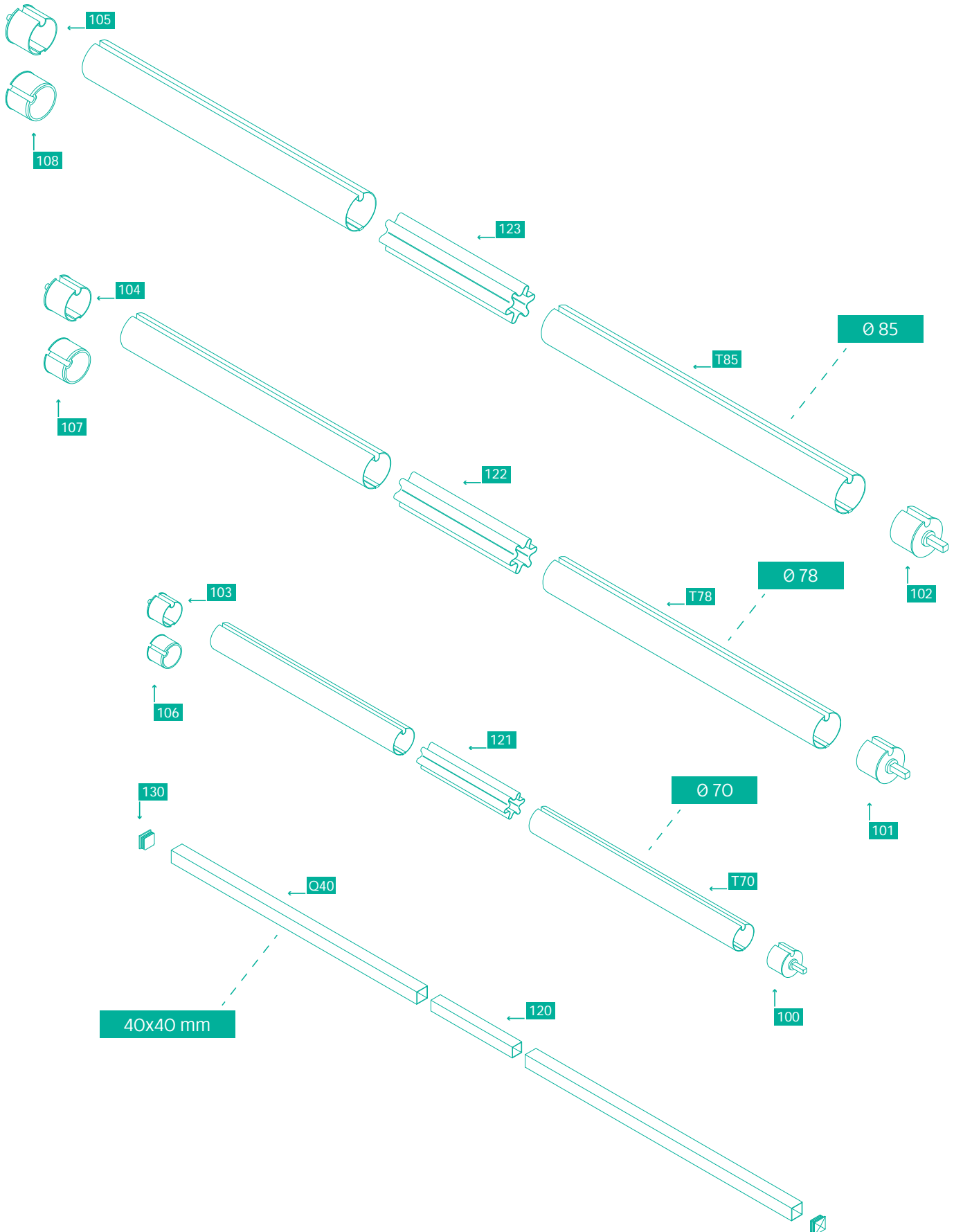



Ø 70 TUBE & ACCESSORIES

tubi & accessori Ø 70  
Ø 70 tube & accessories

Tuchwelle & Zubehör Ø 70  
tube & composants Ø 70

acessorios & tubos Ø 70  
acessórios & tubos Ø 70

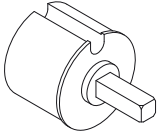
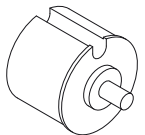
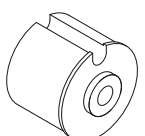
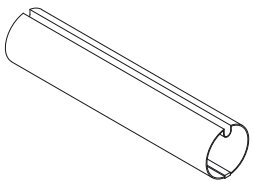
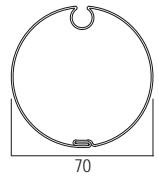
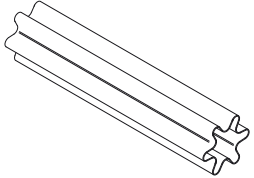
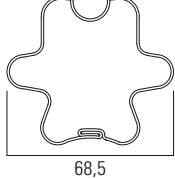
100		2XL911PQ7	calotta in nylon Ø 70 perno quadro 13x40 Ø 70 nylon cap with 13x40 square pin Nylon-Wellenkapsel Ø 70 mit Vierkantstift 13x40 calotte en nylon Ø 70 pivot carré 13x40 casquillo de nylon Ø 70 perno cuadrado 13x40 calote em nylon Ø 70 eixo quadrado 13x40		1 PZ	
103		2XL911PT7	calotta in nylon Ø 70 perno tondo 12x20 Ø 70 nylon cap with 12x20 round pin Nylon-Wellenkapsel Ø 70 mit 12x20 mm Rundstift calotte en nylon Ø 70 pivot rond 12x20 casquillo de nylon Ø 70 perno redondo 12x20 calote em nylon Ø 70 eixo redondo 12x20		1 PZ	
106		2XL910F7	calotta in nylon Ø 70 con foro tondo Ø 70 nylon cap with hole Nylon-Wellenkapsel Ø 70 mit rundem Loch calotte en nylon d Ø 70 avec trou casquillo de nylon Ø 70 con agujero calote em nylon Ø 70 com furo		1 PZ	
T70		RULA70X10/10L4000 RULA70X10/10L5000 RULA70X10/10L6000 RULA70X10/10L7000	tubo avvolgitore Ø 70 (10/10) Ø 70 roller tube (10/10) Tuchwelle Ø 70 (10/10) tube enrouleur Ø 70 (10/10) tubo de enrollé Ø 70 (10/10) tubo enrolador Ø 70 (10/10)		4 PZ	
121		GIUN3	giunzione per tubo avvolgitore Ø 70 Ø 70 joint roller tube support Tuchwellen Kupplung Ø 70 jonction Ø 70 support tube enrouleur junta para tubo de enrollé Ø 70 junção para tubo enrolador Ø 70		1 PZ	

Ø 78 TUBE & ACCESSORIES

tubi & accessori Ø 78  
Ø 78 tube & accessories

Tuchwelle & Zubehör Ø 78  
tube & composants Ø 78

acessorios & tubos Ø 78  
acessórios & tubos Ø 78

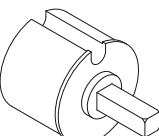
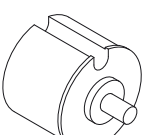
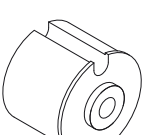
101		2XL912PQ78	calotta in nylon Ø 78 perno quadro 13x40 Ø 78 nylon cap with 13x40 square pin Nylon-Wellenkapsel Ø 78 mit 13x40mm Vierkantstift calotte en nylon Ø 78 pivot carré 13x40 casquillo de nylon Ø 78 perno cuadrado 13x40 calote em nylon Ø 78 eixo quadrado 13x40		1 PZ	
104		2XL912PT78	calotta in nylon Ø 78 perno tondo 12x20 Ø 78 nylon cap with 12x20 round pin Nylon-Wellenkapsel Ø 78 mit 12x20 mm Rundstift calotte en nylon Ø 78 pivot rond 12x20 casquillo de nylon Ø 78 perno redondo 12x20 calote em nylon Ø 78 eixo redondo 12x20		1 PZ	
107		2XL912F78	calotta in nylon Ø 78 con foro Ø 78 nylon cap with hole Ø 78 Nylon-Wellenkapsel mit Loch calotte en nylon d Ø 78 avec trou casquillo de nylon Ø 78 con agujero calote em nylon Ø 78 com furo		1 PZ	

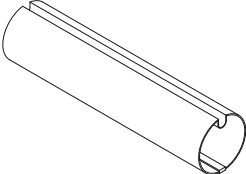
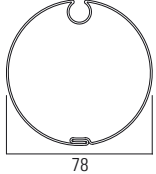
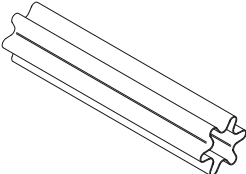
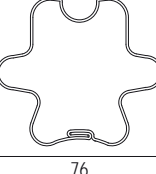
T78		RULA78X10/10L4000 RULA78X10/10L5000 RULA78X10/10L6000 RULA78X10/10L7000	tubo avvolgitore Ø 78 (10/10) Ø 78 roller tube (10/10) Tuchwelle Ø 78 (10/10) tube enrouleur Ø 78 (10/10) tubo de enrolle Ø 78 (10/10) tubo enrolador Ø 78 (10/10)		400 cm 500 cm 600 cm 700 cm	4 PZ	
122		GIUN4	giunzione per tubo avvolgitore Ø 78 Ø 78 joint roller tube support Tuchwellen Kupplung Ø 78 jonction Ø 78 support tube enrouleur junta para tubo de enrolle Ø 78 junção para tubo enrolador Ø 78			1 PZ	

### Ø 85 TUBE & ACCESSORIES

tubi & accessori Ø 85  
 Ø 85 tube & accessories

Tuchwelle & Zubehöre Ø 85  
 tube & composants Ø 85

acessorios & tubos Ø 85  
 acessórios & tubos Ø 85

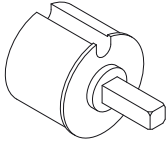
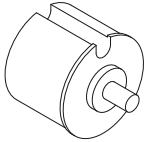
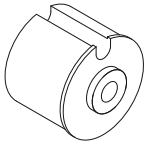
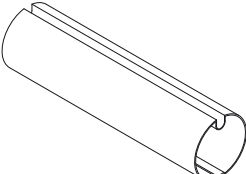
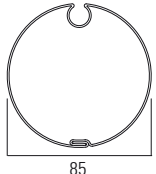
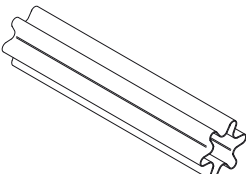
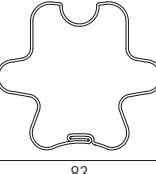
102		2XL912PQ85	calotta in nylon Ø 85 perno quadro 13x40 Ø 85 nylon cap with 13x40 square pin Nylon-Wellenkapsel Ø 85 mit 13x40 mm Vierkantstift calotte en nylon Ø 85 pivot carré 13x40 casquillo de nylon Ø 85 perno cuadrado 13x40 calote em nylon Ø 85 eixo quadrado 13x40		1 PZ		
105		2XL912PT85	calotta in nylon Ø 85 perno tondo 12x20 Ø 85 nylon cap with 12x20 round pin Nylon-Wellenkapsel Ø 85 mit 12x20 mm Rundstift calotte en nylon Ø 85 pivot rond 12x20 casquillo de nylon Ø 85 perno redondo 12x20 calote em nylon Ø 85 eixo redondo 12x20		1 PZ		
108		2XL912F85	calotta in nylon Ø 85 con foro Ø 85 nylon cap with hole Ø 85 Nylon-Wellenkapsel mit Loch calotte en nylon Ø 85 avec trou casquillo de nylon Ø 85 con agujero calote em nylon Ø 85 com furo		1 PZ		
T85		RULA85X12/10L5000 RULA85X12/10L6000 RULA85X12/10L7000	tubo avvolgitore Ø 85 (12/10) Ø 85 rollertube (12/10) Tuchwelle Ø 85 (12/10) tube enrouleur Ø 85 (12/10) tubo de enrolle Ø 85 (12/10) tubo enrolador Ø 85 (12/10)		500 cm 600 cm 700 cm	1 PZ	
123		GIUN5	giunzione per tubo avvolgitore Ø 85 Ø 85 joint roller tube support Tuchwellen Kupplung Ø 85 jonction Ø 85 support tube enrouleur junta para tubo de enrolle Ø 85 junção para tubo enrolador Ø 85			1 PZ	



## SQUARE BAR & JOINT

barra quadra & giunzione  
square bar & joint

Vierkant-Tragrohr & Kupplung  
barre carrée & jonction

barra cuadrada & junta  
barra quadrada & junção

Q40		BQ40X40L4000 BQ40X40L5000 BQ40X40L6000 BQ40X40L7000	barra quadra mm 40x40 40x40 mm square bar Vierkant-Tragrohr 40x40 mm barre carrée 40x40 mm barra cuadrada mm 40x40 barra quadrada mm 40x40		400 cm 500 cm 600 cm 700 cm	1 PZ	
120		GIUN1	giunzione 35x35 mm per barra quadra e terminali 35x35 mm square bar and terminal bar joint Kupplung 35x35 mm für Ausfallprofil und Vierkant-Tragrohr jonction diam 35x35 pour barre carrée et barres de charge junta 35x35 mm para barra cuadrada y de carga junção 35x35 mm para barra quadrada e terminais			1 PZ	

## OTHER FREQUENT COMPONENTS

altri componenti frequenti  
other frequent components

Andere Häufige Zubehöre  
autres composants communs

otros componentes comunes  
outros componentes comuns

130		PFTAPBQ	tappo PVC per barra quadra mm 40x40 40x40 mm square bar PVC cap PVC-Deckel für Vierkant-Tragrohr 40x40 mm bouchon PVC barre carrée 40x40 mm tapa PVC para barra cuadrada mm 40x40 tampa PVC para barra quadrada mm 40x40			1 CP	
140		PFASM120 PFASM150 PFASM180 PFASM200 PFASM220 PFASM250	asta manovra crank rod Bedienungsstange manivelle manivela manivela		120 cm 150 cm 180 cm 200 cm 220 cm 250 cm	1 PZ       10 PZ	

# HOOD

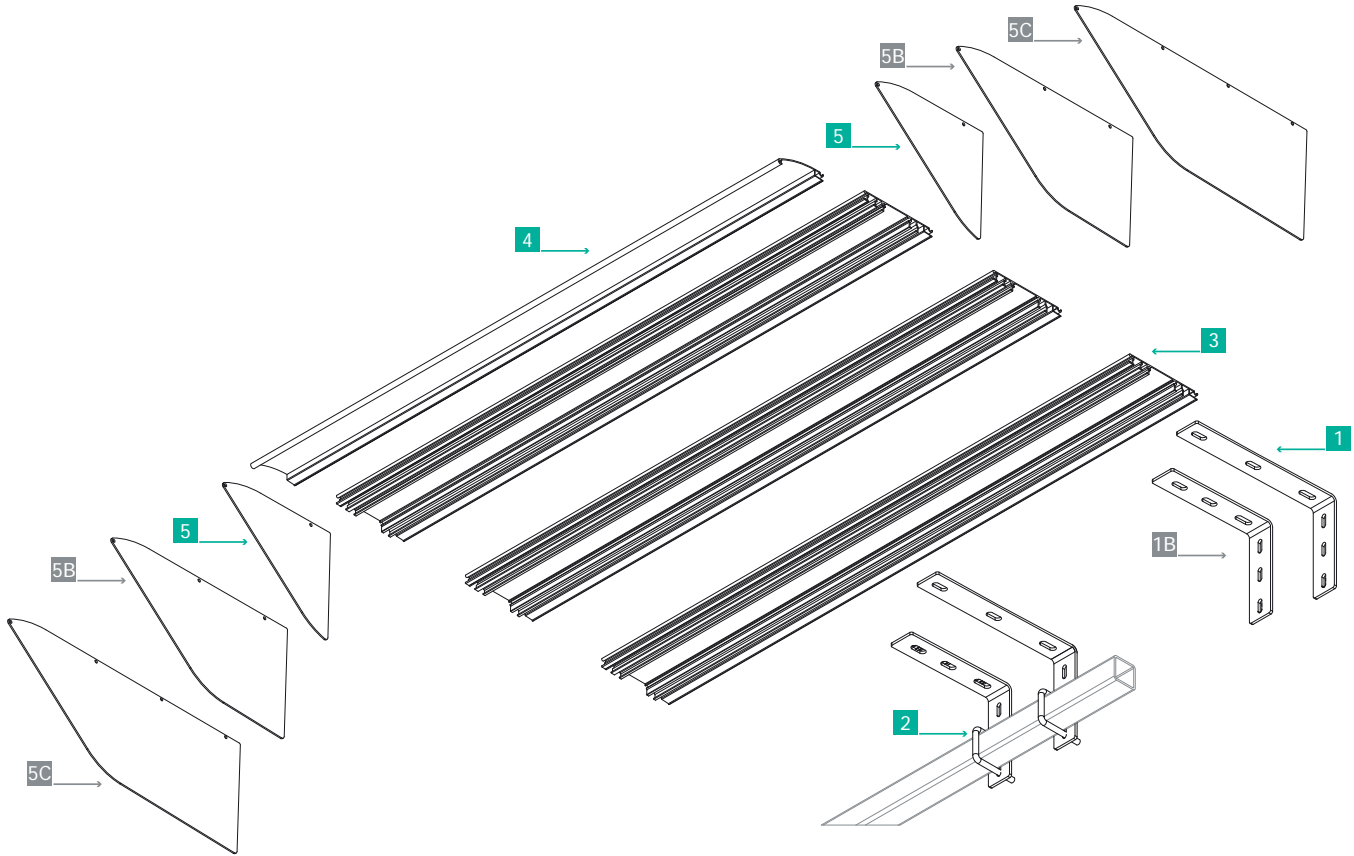

## HOOD

## HO

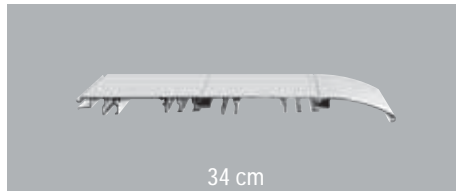

N°						
1		MENATTET01	staffetta a muro per tettuccio per 47 cm wall bracket for hood for 47 cm Wandhalter für Schutzdach für 47 cm étrier au mur pour auvent pour 47 cm soporte de pared para tejado para 47 cm suporte de parede para telhado para 47 cm			1 PZ
1B		MENATTET02	staffetta a muro per tettuccio per 21 cm o 34 cm wall bracket for hood for 21 cm or 34 cm Wandhalter für Schutzdach für 21 cm oder 34 cm étrier au mur pour auvent pour 21 cm ou 34 cm soporte de pared para tejado para 21 cm o 34 cm suporte de parede para telhado para 21 cm ou 34 cm			1 PZ
2		CAVATTETBQ	particolare a "U" inox inox "U" piece U-Stück Inox piece "U" en inox peça "U" inox			1 PZ
3		TETMEL4000 TETMEL5000 TETMEL6000 TETMEL7000	tettuccio in alluminio intermedio 13 cm intermediary aluminium hood cm 13 mittlerer Aluminium Schutzdach cm 13 auvent aluminium intermédiaire cm 13 tejadillo de aluminio intermedio cm 13 telhado de alumínio intermediário cm 13		400 cm 500 cm 600 cm 700 cm	1 PZ

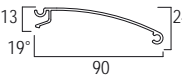
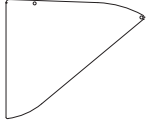
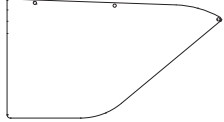
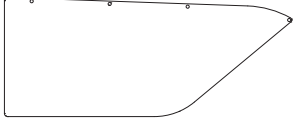
4		<p>TETFIL4000 TETFIL5000 TETFIL6000 TETFIL7000</p>	<p>tettuccio in alluminio finale 9 cm final aluminium hood cm 9 Aluminium Endschutzdach cm 9 auvent aluminium final cm 9 tejadillo de aluminio final cm 9 telhado de alumínio final cm 9</p>		<p>400 cm 500 cm 600 cm 700 cm</p>	<p>1 PZ</p>
5		<p>TETTES01</p>	<p>testata per tettuccio spessore 21 cm head for hood projection cm 21 Kopfstoß für Schutzdach - Stärke cm 21 tête pour auvent avancée cm 21 sometidas tejadillo espesor 21 cm testadas para telhado espessura cm 21</p>		<p>21 cm</p>	<p>1 CP</p>
5B		<p>TETTES02</p>	<p>testata per tettuccio spessore 34 cm head for hood projection cm 34 Kopfstoß für Schutzdach - Stärke cm 34 tête pour auvent avancée cm 34 sometidas tejadillo espesor 34 cm testadas para telhado espessura cm 34</p>		<p>34 cm</p>	<p>1 CP</p>
5C		<p>TETTES03</p>	<p>testata per tettuccio spessore 47 cm head for hood projection cm 47 Kopfstoß für Schutzdach - Stärke cm 47 tête pour auvent avancée cm 47 sometidas tejadillo espesor 47 cm testadas para telhado espessura cm 47</p>		<p>47 cm</p>	<p>1 CP</p>

HOOD ON BRACKET FOR SQUARE BAR

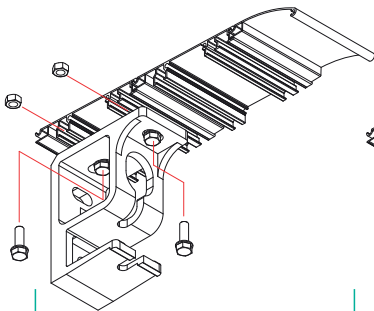

staffa universale  
universal bracket  
universale Konsole  
étrier de fixation universel  
soporte universal  
estribo universal

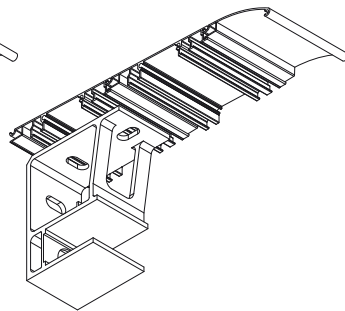

staffa universale in estrusione  
extruded universal bracket  
Stranggepresste universale Konsole  
étrier de fixation universel en extrusion  
soporte universal en extrusión  
estribo universal em expulsão

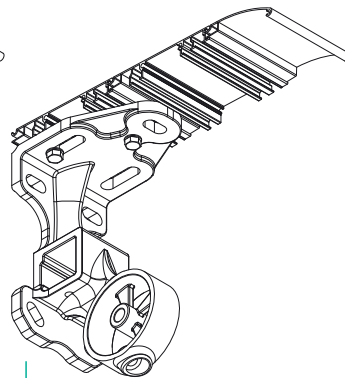

staffa renoir con disco  
renoir bracket with disk  
Renoir Konsole mit Scheibe  
support renoir avec disque  
soporte renoir com disco  
suporte renoir com disco

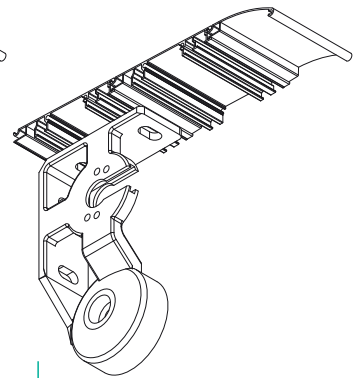

staffa giorgione con disco  
giorgione bracket with disk  
Halter Giorgione mit Scheibe  
support giorgione avec disque  
soporte giorgione con disco  
estribo giorgione com disco

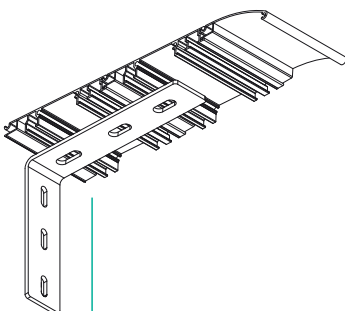

staffetta a muro per tettuccio per 21 cm, 34 cm o 47 cm  
wall bracket for hood for 47 cm for 21 cm, 34 cm or 47 cm  
Wandhalter für Schutzdach für 47 cm für 21 cm, 34 cm oder 47 cm  
étrier au mur pour auvent pour 47 cm pour 21 cm, 34 cm ou 47 cm  
soporte de pared para tejado para 47 cm para 21 cm, 34 cm o 47 cm  
soporte de parede para telhado para 47 cm para 21 cm, 34 cm ou 47 cm

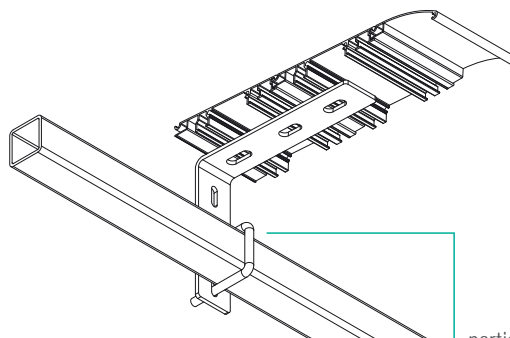

particolare a "U" inox  
inox "U" piece  
U-Stück Inox  
piece "U" en inox  
pieza "U" inox  
peça "U"inox



# GUSCIO



sporgenza max | max projection | maximale Ausladung  
avancée maximale | salida máx | saliência máxima

## 400 cm

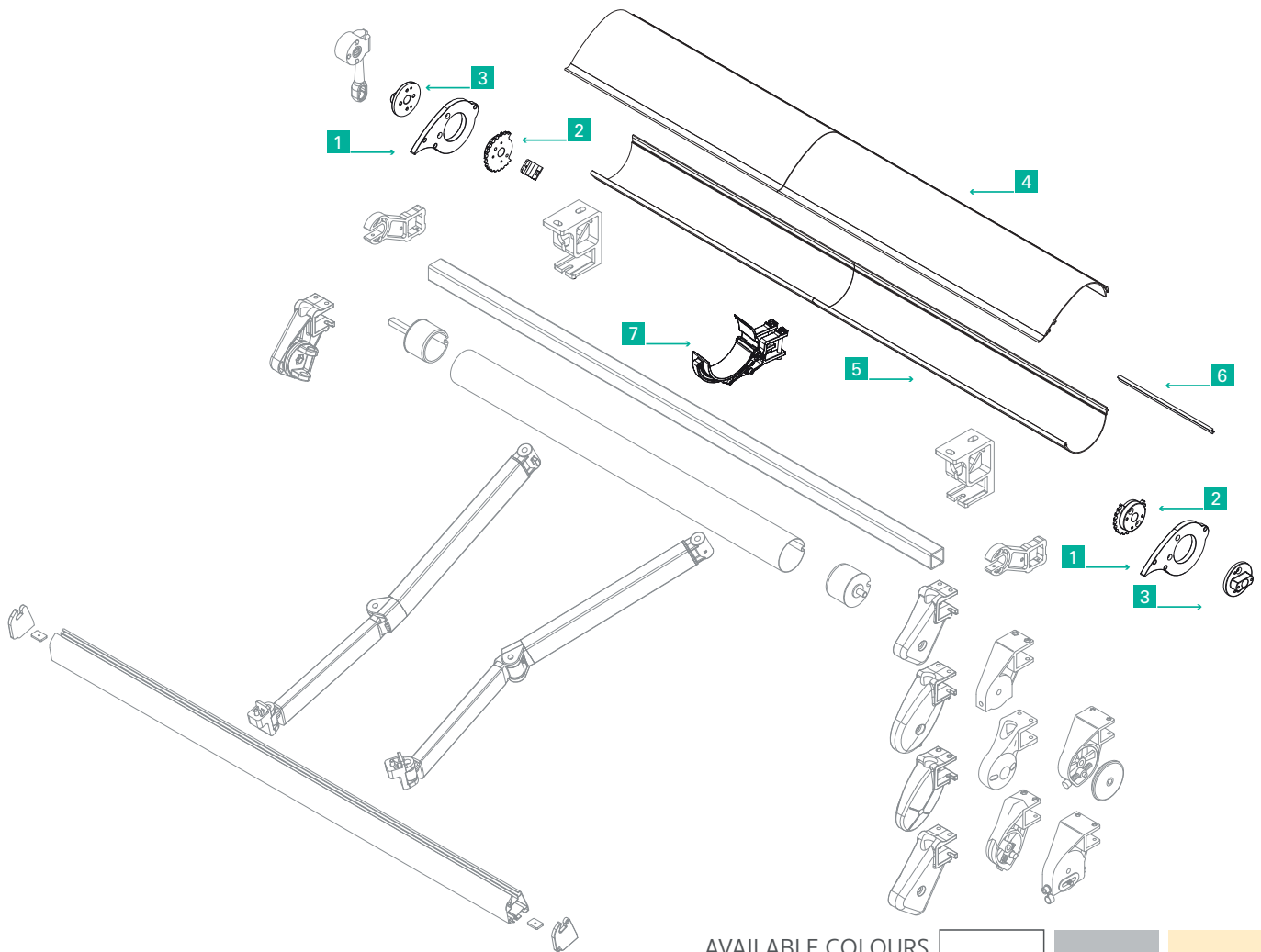

AVAILABLE COLOURS     
RAL 9010 7035 1013

### GUSCIO



### GU

### JOINT GUSCIO

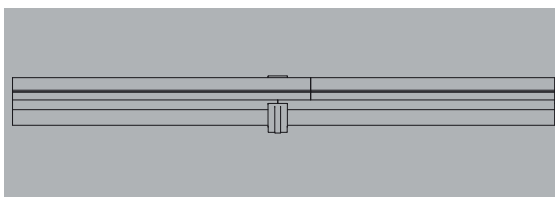

### AVAILABLE FOR AWNING

disponibile per tenda  
available for awning

SIGNORELLI 170	sp. max 425 cm
BERNINI	sp. max 400 cm
CANOVA	sp. max 400 cm
RAFFAELLO	sp. max 350 cm
MODIGLIANI	sp. max 350 cm

Erhältlich für folgende Markisen  
disponible pour store

BALLA	sp. max 350 cm
TIZIANO	sp. max 350 cm
BOTTICELLI 170	sp. max 350 cm
DE CHIRICO	sp. max 350 cm
BOTTICELLI 140	sp. max 300 cm

disponibile para toldo  
disponibilidade por toldo

CARAVAGGIO	sp. max 250 cm
MARINETTI	sp. max 250 cm
SANSOVINO	sp. max 250 cm

N°						
1		8XL003	testata guscio guscio-cassette caps Deckel für Guscio-Kassette capuchons pour coffre Guscio tapas para caja-Guscio tampas para caixa -Guscio		1 CP	
2		8XL002	disco di rotazione guscio guscio-cassette rotation's disc Rotationssscheibe Guscio disque de rotation coffre guscio disco de rotación guscio disco de rotação guscio		1 CP	
3		8XL001	disassante guscio off-axis for guscio-cassette außeraxial-Zubehör für Guscio hors axe pour coffre guscio despeje para cajón guscio disassante de caixa guscio		1 CP	
4		B002L5000 B002L6000 B002L7000	profilo superiore guscio cassette upper profile oberes Kassettenprofil profil supérieur coffre perfil superior cajón guscio perfil superior caixote guscio		500 cm 600 cm 700 cm	1 PZ
5		B003L5000 B003L6000 B003L7000	profilo inferiore guscio cassette lower profile unteres Kassettenprofil profil inférieur coffre perfil inferior cajón guscio perfil inferior caixote pinturicchio		500 cm 600 cm 700 cm	1 PZ

**KIT GUSCIO**

kit guscio  
kit cassette

Kit Gehäuse  
kit guscio-coffre

kit caja-guscio  
kit cofre-guscio



8XLGU1

kit guscio  
kit guscio-cassette  
Kit Gehäuse-Guscio  
kit guscio-coffre  
kit caja-guscio  
kit cofre-guscio

1 + 2 + 3

1 PZ

**OPTIONAL**

optional disponibili per questa tenda  
extras available for this awning

vorhandene Möglichkeiten für diese Markise  
options disponibles pour ce store

opciones disponibles para este toldo  
opções disponíveis para este toldo

6		10XLEKSPAZ	spazzolino brush Bürste brosse cepillo escova		1 ML 250 ML	
7		8XL005	supporto compensatore guscio balance support guscio Ausgleichsstütz Guscio support compensateur guscio soporte compensador guscio suporte compensador guscio		1 PZ	

# ROLLÒ



larghezza max | max width cm | Max. Breite cm  
 largeur max cm | ancho máx cm | largura max cm

700 cm

altezza max | max height | maximale Höhe  
 hauteur max | salida máx | saliência máxima

140 cm

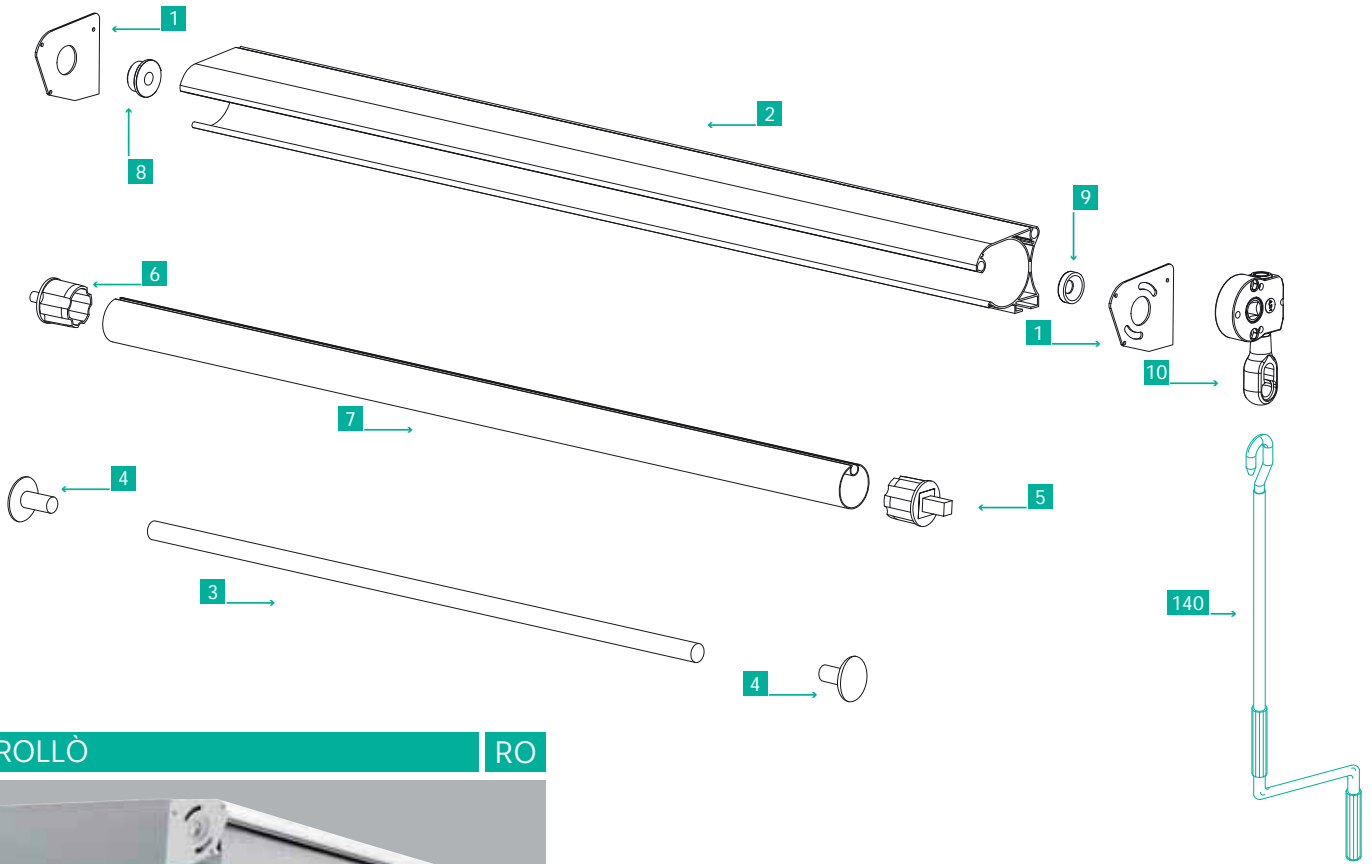

ROLLÒ

RO



AVAILABLE COLOURS

RAL 9010

## AVAILABLE FOR AWNING

disponibile per tenda  
 available for awning

SIGNORELLI 170 sp. max 425 cm  
 BERNINI sp. max 400 cm  
 CANOVA sp. max 400 cm  
 RAFFAELLO sp. max 350 cm  
 MODIGLIANI sp. max 350 cm

Erhältlich für folgende Markisen  
 disponible pour store

BALLA sp. max 350 cm  
 TIZIANO sp. max 350 cm  
 BOTTICELLI 170 sp. max 350 cm

disponibile para toldo  
 disponibilidade por toldo

TIEPOLO sp. max 350 cm  
 RENOIR sp. max 350 cm  
 GIORGIONE sp. max 325 cm  
 PERUGINO sp. max 300 cm

N°						
1		4XLABB	testata rollò rollò header Kopfstoß Rollò tête rollò cabecera rollò cabeçada rollò		1 CP	
2		ESTRABBAL7200	cassonetto rollò rollò cassette profile Kassettenprofil Rollò profil coffre rollò perfil cajón rollo caixote rollo		720 cm	1 PZ

N°						
3		ESTRTTL4800 ESTRTTL7000	terminale tondo round terminal bar Runde Ende-Ausfallprofil barre de charge ronde barra de carga redonda barra terminal redonda			1 PZ 5 PZ
4		931TAOVL	tappo terminale rollò rollò terminal bar end cover Deckel für Ende-Ausfallprofil Rollò bouchon barre de charge rollò tapa barra de carga rollò tampa barra terminal rollò			1 CP
5		4XL910PQ43	calotta in nylon Ø 43 perno quadro 13x30 Ø 43 nylon cap with 13x30 square pin Nylon-Wellenkapsel Ø 43 mit 13x30 mm Vierkantstift calotte en nylon Ø 43 pivot carré 13x30 casquillo de nylon Ø 43 perno cuadrado 13x30 calote em nylon Ø 43 eixo quadrado 13x30			1 PZ
6		4XL910PT43	calotta in nylon Ø 43 perno tondo 12x20 Ø 43 nylon cap with 12x20 round pin Nylon-Wellenkapsel Ø 43 mit 12x20 mm Rundstift calotte en nylon Ø 43 pivot rond 12x20 casquillo de nylon Ø 43 perno redondo 12x20 calote em nylon Ø 43 eixo redondo 12x20			1 PZ
7		RULA43X8/10L7000	tubo avvolgitore Ø 43 (8/10) Ø 43 roller tube (8/10) Tuchwelle Ø 43 (8/10) tube enrouleur Ø 43 (8/10) tubo de enrollé Ø 43 (8/10) tubo enrolador Ø 43 (8/10)		700 cm	1 PZ
8		4XLBOAB	boccola lato folle bushing AB Buchse bague AB buse busha			1 PZ
9		10XLRON	rondella pvc TC PVC-waher TC PVC-Dichtungsring TC rondelle pvc TC arandela pvc TC arruela pvc TC			1 PZ
10		PFARG471	arganello 4.7/1 reduction winch 4.7/1 Wunsch 4.7/1 treuil 4.7/1 máquina sinfin 4.7/1 sarilho 4.7/1			1 PZ
		4XLABMKIT	kit per motore motor kit Motor Set kit pour moteur kit para motor kit para motor		1 + 6 + 8	1 PZ
		4XLABAKIT	kit per argano kit for reduction winch wansch Set kit pour treuil kit por máquina sinfin kit para sarilho		1 + 5 + 6 + 8 + 9	1 PZ



### LED SYSTEM

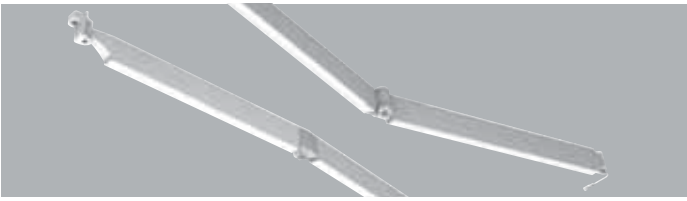

### LAYOUT FOR 1 AWNING

schema per 1 tenda  
layout for 1 awning

Schema für 1 Markisen  
plan pour 1 store

esquema para 1 toldo  
esquema para 1 toldo

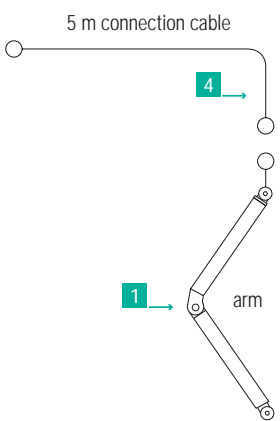
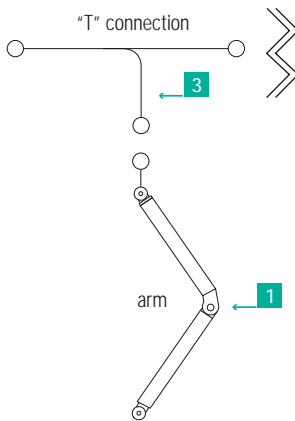
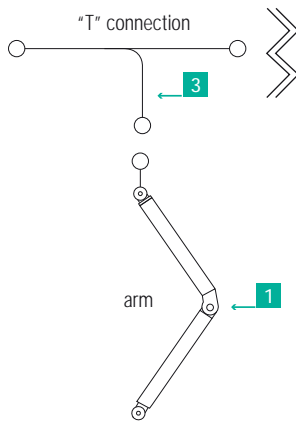
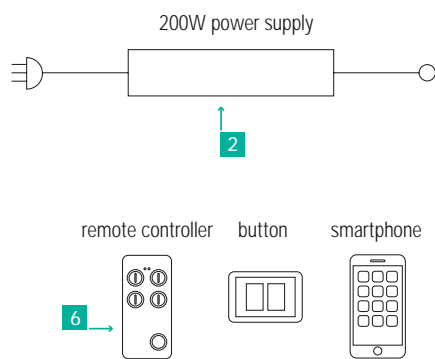

for n° connectable arms see table

### LAYOUT FOR 2 AWNING

schema per 2 tende  
layout for 2 awning

Schema für 2 Markisen  
plan pour 2 store

esquema para 2 toldo  
esquema para 2 toldo

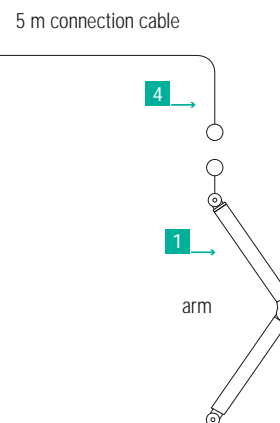
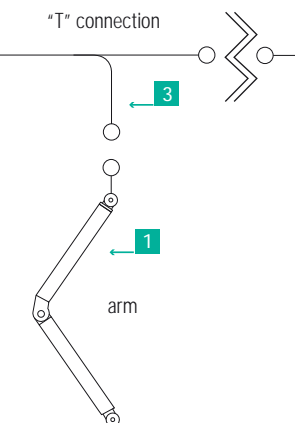
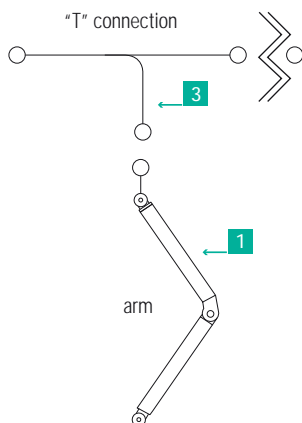
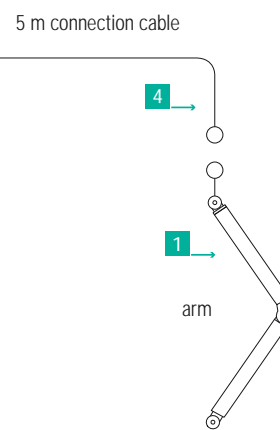
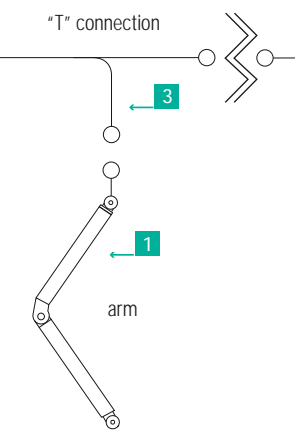
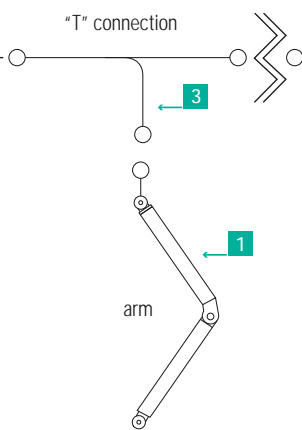
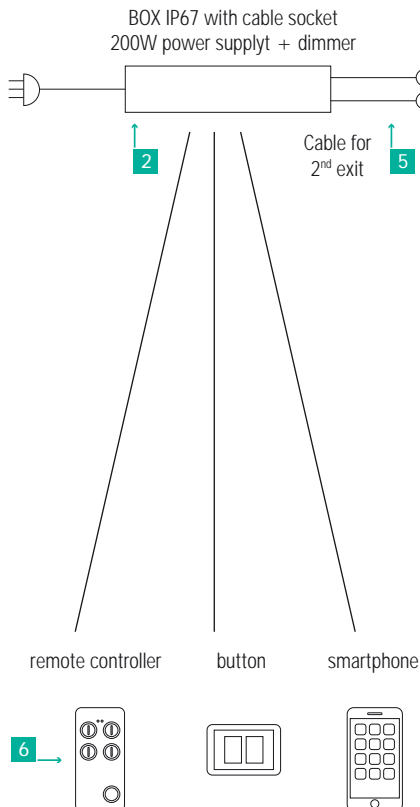

for n° connectable arms see table

AVAILABLE FOR AWNING

disponibile per tenda  
available for awning

Erhältlich für folgende Markisen  
disponible pour store

disponibile para toldo  
disponibilidade por toldo



RAFFAELLO  
MODIGLIANI  
BALLA  
TIZIANO  
DE CHIRICO

TIEPOLO  
RENOIR  
GIORGIONE  
PERUGINO

GIOTTO

N° 

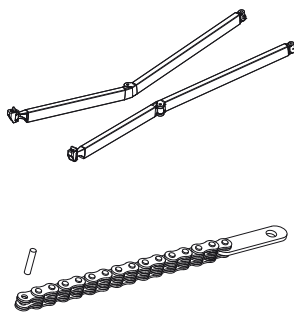
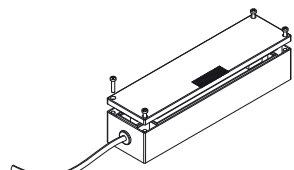

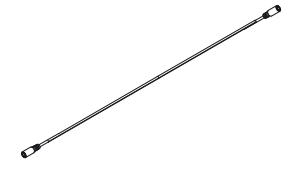
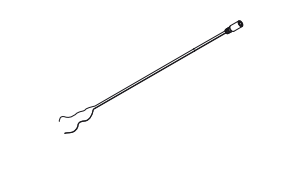
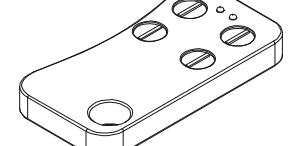
1		<p>2XL150CASLD 2XL175CASLD 2XL200CASLD 2XL225CASLD 2XL250CASLD 2XL275CASLD 2XL300CASLD 2XL325CASLD 2XL350CASLD</p>	<p>braccio cassiopea led cassiopea led arm Gelenkarm Cassiopea led bras cassiopea led brazo cassiopea led braço cassiopea led</p>	<p>150 cm 175 cm 200 cm 225 cm 250 cm 275 cm 300 cm 325 cm 350 cm</p>	1 CP	
2		PFALBOX1	<p>power supply + dimmer 200W IP65 with button/radio/wifi power supply + dimmer 200W IP65 with button/radio/wifi power supply + dimmer 200W IP65 with button/radio/wifi power supply + dimmer 200W IP65 with button/radio/wifi power supply + dimmer 200W IP65 with button/radio/wifi power supply + dimmer 200W IP65 with button/radio/wifi</p>		1 PZ	
3		PFCVAULT	<p>cavo collegamento a "T" 160/20/160 "T" connection cable 160/20/160 "T" Verbindungskabel 160/20/160 Câble de connexion en "T" 160/20/160 Cable de conexión "T" 160/20/160 Cabo de conexão "T" 160/20/160</p>		1 PZ	
4		PFCVPROL5	<p>cavo collegamento da 5 m 5 m connection cable 5 m Verbindungskabel Câble de connexion de 5 m Cable de conexión de 5 m Cabo de conexão de 5 m</p>		1 PZ	
5		PFCAVBOX	<p>cavetto per box 15 cm cable for box 15 cm Kabel für Box 15 cm câble pour box 15 cm cable para box 15 cm cabo para box 15 cm</p>		1 PZ	
6		PFTELC1	<p>telecomando box remote controller box Fernlenkung Box télécommande box telemando box control remoto box</p>		1 PZ	



## OPTIONAL

optional disponibili per questo braccio  
extras available for this arm type

vorhandene Möglichkeiten für diesen Arm  
options disponibles pour ce bras

opciones disponibles para este brazo  
opções disponíveis para este braço

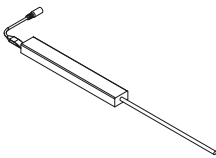
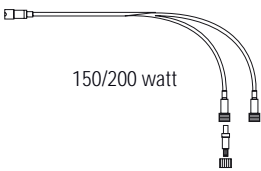
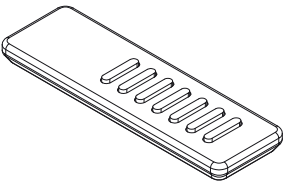
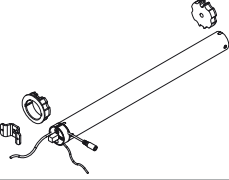
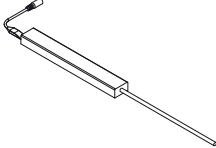
	PFALIM1	kit power supply + dimmer IP44 100W slim kit power supply + dimmer IP44 100W slim kit power supply + dimmer IP44 100W slim kit power supply + dimmer IP44 100W slim kit power supply + dimmer IP44 100W slim kit power supply + dimmer IP44 100W slim		1 PZ	
 150/200 watt	PFCV2USC	cavo 2 uscite indipendenti per alimentatore cable with 2 independent outputs for power supply Verbindungskabel mit 2 Unabhängige Ausgänge für Power Supply cable avec 2 sorties independantes pour l'alimentation cable con 2 salidas independentes para la alimentacion cabo com 2 saidas independentes para alimentação		1 PZ	
	PFTELC	telecomando remote controller Fernlenkung télécommande telemando control remoto		1 PZ	
	PFALIM3	power supply + dimmer compact power supply + dimmer compact power supply + dimmer compact power supply + dimmer compact power supply + dimmer compact power supply + dimmer compact		1 PZ	
	PFALIM2	kit power supply + dimmer IP44 200W kit power supply + dimmer IP44 200W kit power supply + dimmer IP44 200W kit power supply + dimmer IP44 200W kit power supply + dimmer IP44 200W kit power supply + dimmer IP44 200W		1 PZ	

## TABLE CONSUMPTION OF WATT FOR CASSIOPEA LED

arm cm	cm streep led x 1 pair arm	WATT FOR ARM			POWER SUPPLY		
		watt for 1 pair	watt for 2 pair	watt for 3 pair	min watt power for 1 pair	min watt power for 2 pair	min watt power for 3 pair
150	220	22	42	63	25	51	76
175	270	26	52	78	31	62	93
200	320	31	61	92	37	74	111
225	370	36	71	107	43	85	128
250	420	40	81	121	48	97	145
275	470	45	90	135	54	108	162
300	520	50	100	150	60	120	180
325	570	55	109	164	66	131	207
350	610	59	117	177	70	141	211

# CROSSING ARM SYSTEM

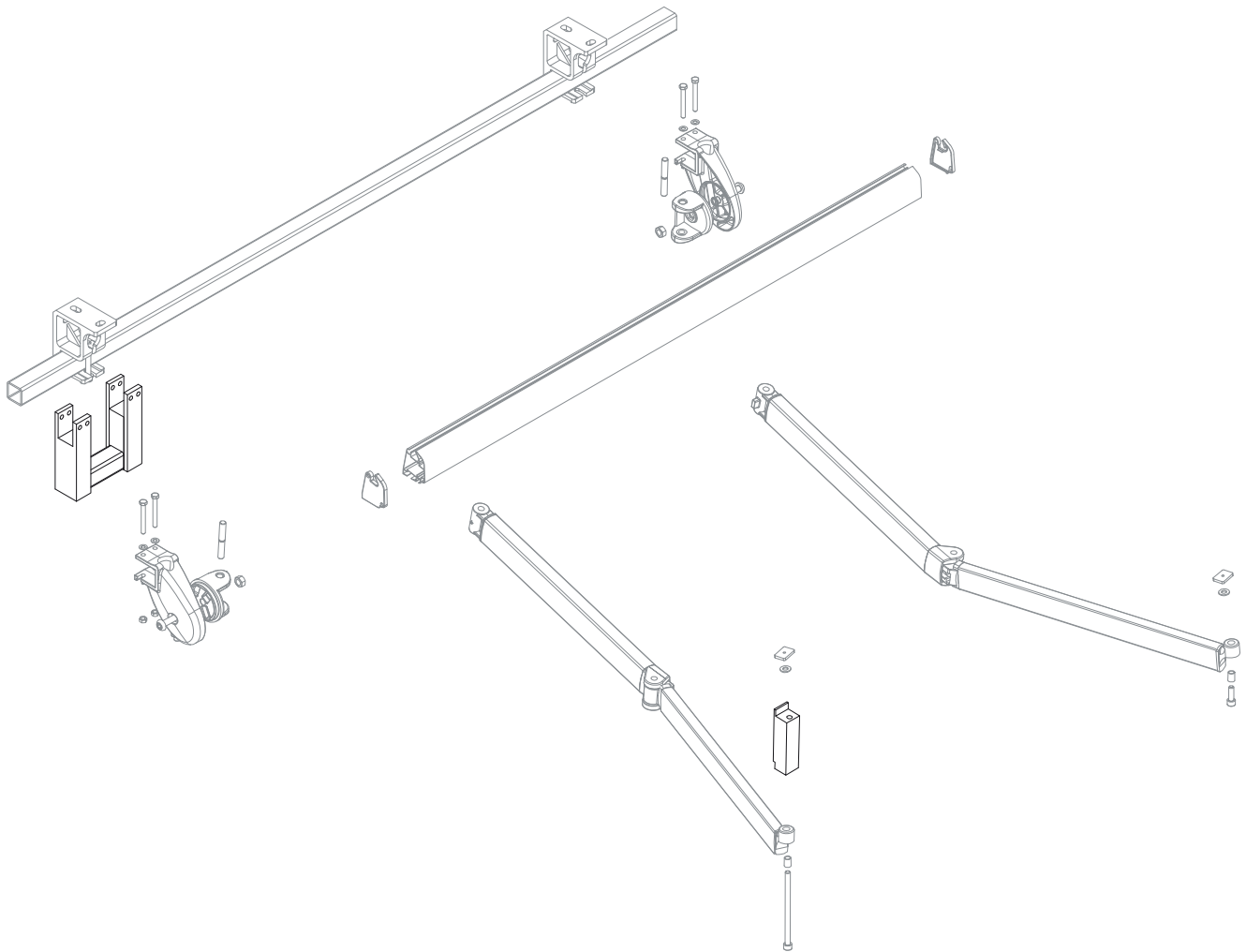

AVAILABLE COLOURS     
RAL 9010 7035 1013

## CROSSING ARM SYSTEM

CA

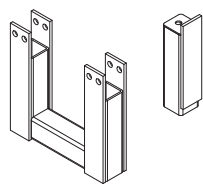
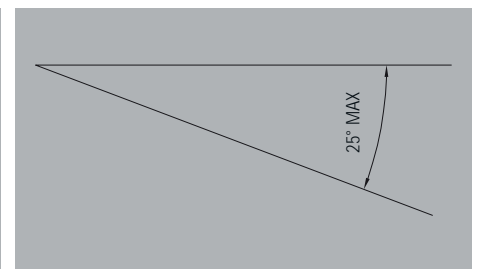

2XL111A

supporto braccio incrociato con prolunga per braccio con prolunga  
crossed arm support with extension for arms with extension  
gekreuzte Armkonsole mit Erweiterung für Arm mit Erweiterung  
étrier de bras croisé avec extension pour bras avec extension  
soporte de brazo cruzado con extensión para brazo con extensión  
sustentação do braço cruzado com extensão para braço com extensão

1 PZ

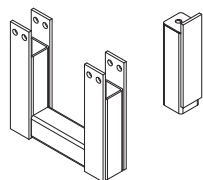

2XL111P

supporto braccio incrociato con prolunga per braccio con puntale pipetta  
crossed arm support with extension for arm with pipette tip  
gekreuzter Arm-Unterstützung mit Ausleger für Arm mit Pipetten-Spitze  
support de bras croisé avec rallonge pour bras avec embout à pipette  
soporte de brazo cruzado con extensión para brazo con punta pipeta  
sustentação do braço cruzado com extensão de braço com ponta pipeta

1 PZ