

A TOUCH OF SHADE

WHY
NOT
?

euromflex 

VERANDA AWNINGS

FLEX PRICE MOLIÈRE

TENDE PER VERANDE

sporgenza massima 600 cm

veranda awnings
max projection 600 cm

Terrassenbeschattungen
maximale Ausladung 600 cm

stores pour vérandas
avancée maximale 600 cm

toldos para terrazas
salida máx 600 cm

toldos para varandas
saliência máxima 600 cm

sistemi	systems	Systeme	systèmes	sistemas	sistemas
componenti	components	Komponenten	composants	componentes	componentes
accessori	accessories	Zubehöre	accessoires	accesorios	acessórios
per tende	for	für	pour bannes	para	para
da sole	awnings	Markisen	stores	toldos	toldos



con tettuccio
with hood
mit Schutzdach
avec auvent
con tejadillo
com telhado



con guscio
with cassette - guscio
mit Gehäuse - guscio
avec coffre - guscio
com cofre-guscio
com caja-guscio



bracci sovrapponibili
crossing arm system
Arme-Senkvorrichtung
kit abaissement bras
kit bajando brazo
kit redusáu braço



modulare
modular
modulierbar
moduler
modular
modular



con arganello
with reduction winch
mit Wunsch
avec treuil
con máquina sinfín
com sarilho



con motore
with motor
mit Motor
avec moteur
con motor
com motor



terminale leggero
light terminal bar
leichtes Ausfallprofil
barre de charge légère
barra de carga ligera
barra terminal leve



terminale pesante
heavy terminal bar
schweres Ausfallprofil
barre de charge lourde
barra de carga pesada
barra terminal pesada



tubo avvolgitore Ø 60
Ø 60 roller tube
Tuchwelle Ø 60
tube enrouleur Ø 60
tubo de enrollo Ø 60
tubo enrolador Ø 60



tubo avvolgitore Ø 70
Ø 70 roller tube
Tuchwelle Ø 70
tube enrouleur Ø 70
tubo de enrollo Ø 70
tubo enrolador Ø 70



tubo avvolgitore Ø 78
Ø 78 roller tube
Tuchwelle Ø 78
tube enrouleur Ø 78
tubo de enrollo Ø 78
tubo enrolador Ø 78



tubo avvolgitore Ø 85
Ø 85 roller tube
Tuchwelle Ø 85
tube enrouleur Ø 85
tubo de enrollo Ø 85
tubo enrolador Ø 85



installazione parete
wall installation
Wandmontage
dressage au mur
instalación pared
instalação parede



installazione soffi tto
ceiling installation
Deckenmontage
dressage plafond
instalación techo
instalação teto



installazione laterale
lateral installation
Seitenmontage
dressage latéral
instalación lateral
instalação lateral



altezza max cm
max height cm
maximale Höhe cm
hauteur max cm
alto máx cm
altura max cm



larghezza max cm
max width cm
maximale Breite cm
largeur max cm
ancho máx cm
largura max cm



sporgenza max cm
max projection cm
maximale Ausladung cm
avancée maximale cm
salida máx cm
saliência max cm



classe 2: sporgenza max cm
class 2: max projection cm
Klasse 2: max. Ausladung cm
classe 2: avancée maximale cm
classe 2: salida máx cm
classe 2: saliência max cm



classe 1: sporgenza max cm
class 1: max projection cm
Klasse 1: max. Ausladung cm
classe 1: avancée maximale cm
classe 1: salida máx cm
classe 1: saliência max cm



Per un corretto funzionamento, il supporto per i bracci incrociati può essere usato con un'angolazione massima della tenda di 40°.

For a correct operation, the support for crossed arms should be used with a maximum awning angle of 40°.

Für einen korrekten Betrieb, die gekreuzte Arme-Senkvorrichtung soll mit maximaler 40° Neigung der Markise verwendet werden.

Pour un bon fonctionnement, le support pour les bras croisés peut être utilisé avec un angle maximal du store de 40°.

Para una explotación correcta, el soporte para los brazos cruzados debe utilizarse con una inclinación máxima del toldo de 40°.

Para um funcionamento correcto, o apoio para os braços cruzados deve ser utilizado com uma inclinação máxima del toldo de 40°.

TUTTE LE MISURE DEI BRACCI SONO INTESE PER SPORGENZA TENDA

JEDE DIMENSION DER ARME BEZIEHT SICH AUF DIE MARKISE-AUSLADUNG

TODAS LAS MEDIDAS DE LOS BRAZOS SE ENTIENDEN POR SALIDA DEL TOLDO

ALL ARM DIMENSIONS ARE REFERRED TO THE AWNING PROTECTION

TOUTES LES MESURES DES BRAS SONT ENTENDUES EN CONSIDERANT L'AVANCEE DU STORE

TODAS AS MEDIDAS DOS BRAÇOS SÃO ENTENDIDAS COMO SALIÊNCIA DO TOLDO



CP = coppia - pair - Paar - paire - pareja - par
PZ = pezzi - pieces - Stück - pièces - pieza - peças
ML = metro lineare - linear meter - Laufmeter - mètre linéaire - metro lineal - metro linear

tenda
awning
store
markise
toldo
toldo

sporgenza max cm
maximum projection cm
maximale Ausladung cm
avancée maximale cm
salida máx cm
saliência máxima cm

numero pagina
page no.
Seite Nr.
page n°
número de página
página número

GIANT

for projections up to 6 meters

DA VINCI	600 cm	6
DA VINCI PL	600 cm	10
DA VINCI COVER	600 cm	14
DA VINCI COVER PL	600 cm	18
BRUNELLESCHI	600 cm	22



DA VINCI

sporgenza max
max projection
maximale Ausladung
avancée maximale
salida máx
saliência máxima

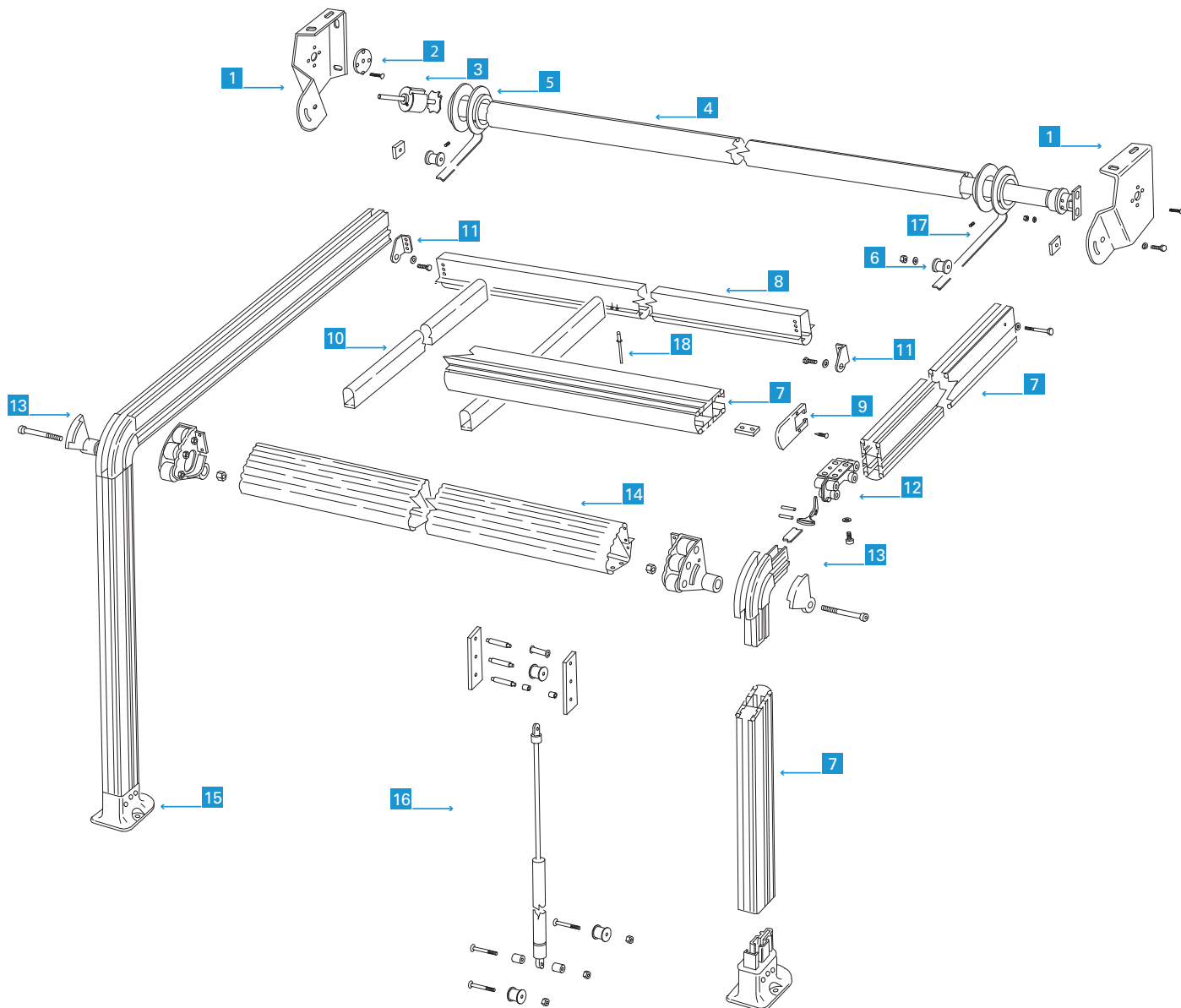
600 cm

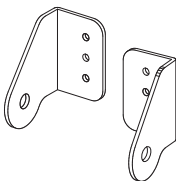
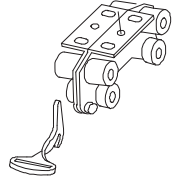
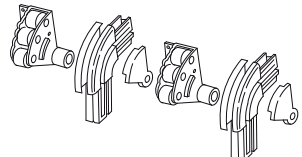
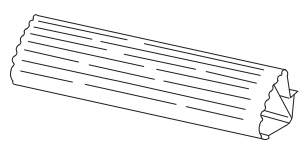
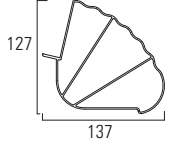
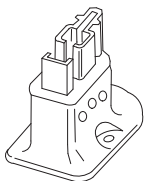
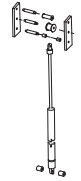
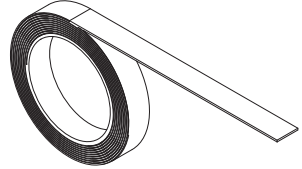

N°						€
1		14XLWLSMO	<p>staffa laterale da vinci da vinci lateral bracket Seitenklammer zur Da Vinci Markise étrier latéral pour da vinci soporte lateral del da vinci suporte lateral da vinci</p>		1 CP	
2		14XLWBOAC	<p>boccola in acetale Ø 12x70 Ø 12x70 acetalic bushes Acetal-Hülse Ø 12x70 douille acétal Ø 12x70 buje de acetálica Ø 12x70 acetal bucha Ø 12x70</p>		1 PZ	
3		15XLCPT85	<p>calotta in alluminio Ø 85 perno tondo regolabile 85 Ø Aluminium cap with adjustable round pin einstellbarer Aluminiumdeckel Ø 85 Rundstift calotte en aluminium 85 Ø pivot rond réglable tapa de aluminio Ø 85 pines redondo regulable tampa de alumínio Ø 85 pino redondo ajustável</p>		1 PZ	
4		RULA85X12/10L5000 RULA85X12/10L6000	<p>tubo avvolgitore Ø 85 (10/10) Ø 85 roller tube (10/10) Tuchwelle Ø 85 (10/10) tube enrouleur Ø 85 (10/10) tubo de enrollar Ø 85 (10/10) tubo enrolador Ø 85 (10/10)</p>		500 cm 600 cm	1 PZ
5		14XLWGH85	<p>ghiere Ø 85 per guida cinghia 85 Ø threaded nut for belt guide Ringe Ø 85 für Riemen-Führung embout Ø 85 pour guide sangle anillos Ø 85 para guía de correa mostradores Ø 85 para condução de correa</p>		1 CP	
6		14XLWRINCI	<p>rullo rinvio cinghia belt pulley Walze für Riemen-Rückkehr rouleau de renvoi sangle rodillo correa de transmisión transmissão da correa rolo</p>		1 PZ	
7		14XLWGUIL5000 14XLWGUIL6000 14XLWGUIL7000	<p>guida e terminale da vinci da vinci guide and terminal profile Da Vinci Führung und Ende-Ausfallprofil guide et barre de charge da vinci guía y terminal da vinci guia e terminal da vinci</p>		500 cm 600 cm 700 cm	1 PZ
8		14XLWFRTRL4650 14XLWFRTRL5750 14XLWFRTRL7000	<p>frangitratta trasversale da vinci da vinci transverse windbreake durchquerender Windschott Da Vinci brise-vent transversal da vinci cortavientos transversal da vinci disjuntor cruzado da vinci</p>		465 cm 575 cm 700 cm	1 PZ
9		14XLWTAFRO	<p>tappo frontale da vinci da vinci front cap Da Vinci Vorder-Deckel bouchon frontal da vinci capuchón frontal da vinci tampa frontal da vinci</p>		1 PZ	
10		14XLWFRVEL5000 14XLWFRVEL7000	<p>frangitratta verticale da vinci da vinci vertical windbreake vertikaler Windschott Da Vinci brise-vent vertical da vinci cortavientos vertical da vinci disjuntor verticais da vinci</p>		500 cm 700 cm	1 PZ



N°							
11		14XLWSPROL	supporto profilo laterale da vinci da vinci lateral profile support Da Vinci-Seitenprofilsstütz support profil latéral da vinci soporte perfil lateral Da Vinci apoio perfil lateral da vinci			1 CP	
12		14XLWCARR	carrello di scorrimento da vinci da vinci sliding trolley Gleitschlitten Da Vinci chariot à roulement da vinci carro de deslizamiento da vinci carrinho de rolagem da vinci			1 PZ	
13		14XLWCURLA	curva laterale da vinci da vinci lateral bend Da Vinci seitliche Kurve coude latéral da vinci curva lateral da vinci lado curva da vinci			1 CP	
14		14XLWFASCL4650 14XLWFASCL5750 14XLWFASCL6800	profilo fascione anteriore da vinci da vinci front band profile Da Vinci Vorderbinde-Profil profil bandeau antérieur perfil faja delantera da vinci perfil frontal de fâscia da vinci		465 cm 575 cm 680 cm	1 PZ	
15		14XLWPPIE	piedino con rullo da vinci da vinci foot with roll Da Vinci Füßchen mit Rollen pied avec rouleau da vinci pie con rodillos da vinci pé com rolo da vinci			1 PZ	
16		14XLWMOGA80 14XLWMOGA105	gruppo molla a gas gas spring with components Gasfeder-Gruppe ressort à gaz avec composants grupo resorte de gas grupo mola a gás		80 cm 105 cm	1 PZ	
17		14XLWCIN	cinghia per da vinci 20x0,9 20x0.9 belt for da vinci Da Vinci Riemen 20x0,9 sangle pour da vinci 20x0,9 correa para da vinci 20x0,9 correia da vinci 20x0,9			1 ML	
18		14XLRIVET	rivetto 4,8x10 4.8x10 rivet Niete 4,8x10 rivet 4,8x10 remache 4,8x10 rebite 4,8x10			1 PZ	

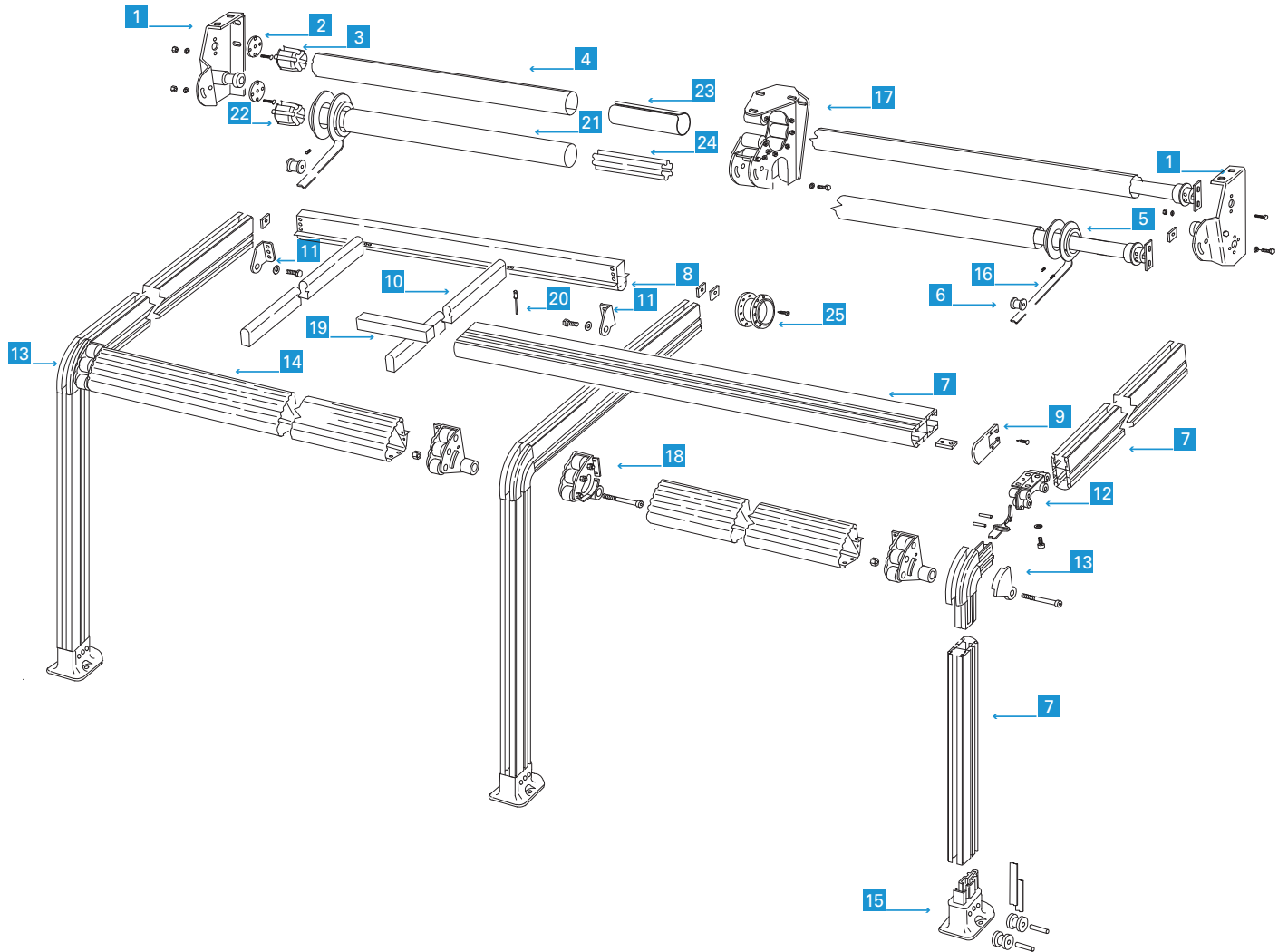

DA VINCI PL

sporgenza max
max projection
maximale Ausladung
avancée maximale
salida máx
saliência máxima

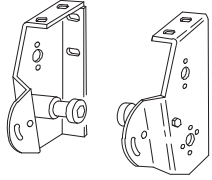
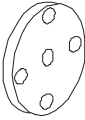
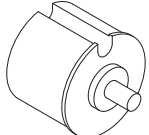
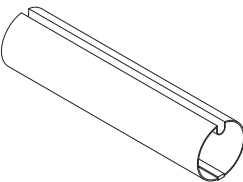
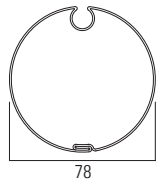
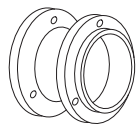
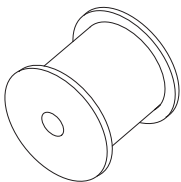
600 cm

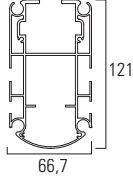
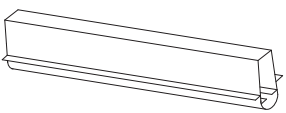
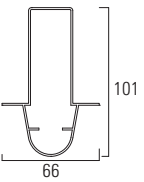
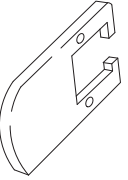
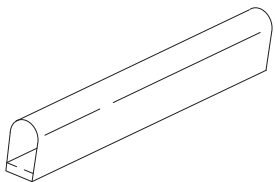
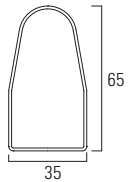

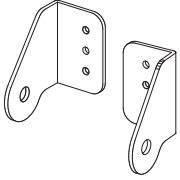
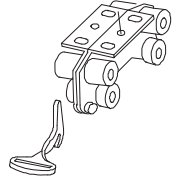
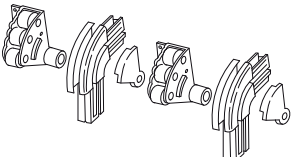
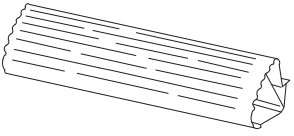
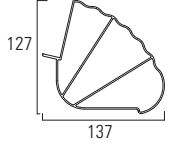
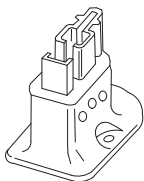
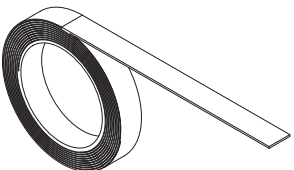
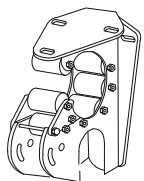
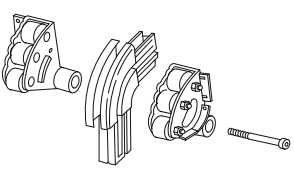
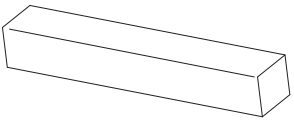
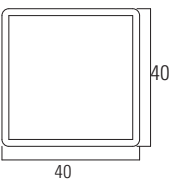
N°						
1		14XLWSLPL	staffa laterale da vinci plurimodulo da vinci multi-module lateral bracket Seitenklammer zur Da Vinci Merfach-Module étrier latéral pour module multiple da vinci soporte lateral del da vinci varios módulos suporte lateral da vinci plurimodulo			1 CP
2		14XLWBOAC	boccola in acetilica Ø 12x70 Ø 12x70 acetalic bushes Acetal-Hülse Ø 12x70 douille acétal Ø 12x70 buje de acetálica Ø 12x70 acetal bucha Ø 12x70			1 PZ
3		2XL912PT78	calotta in nylon Ø 78 perno tondo 12x20 Ø 78 nylon cap with 12x20 round pin Nylon-Wellenkapsel Ø 78 mit 12x20 mm Rundstift calotte en nylon Ø 78 pivot rond 12x20 casquillo de nylon Ø 78 perno redondo 12x20 calote em nylon Ø 78 eixo redondo 12x20			1 PZ
4		RULA78X10/10L4000 RULA78X10/10L5000 RULA78X10/10L6000 RULA78X10/10L7000	tubo avvolgitore Ø 78 (10/10) Ø 78 roller tube (10/10) Tuchwelle Ø 78 (10/10) tube enrouleur Ø 78 (10/10) tubo de enrollar Ø 78 (10/10) tubo enrolador Ø 78 (10/10)		400 cm 500 cm 600 cm 700 cm	4 PZ
5		14XLWGH71	ghiere Ø 71 Ø 71 threaded nut Ringe Ø 71 embout Ø 71 anillos Ø 71 mostradores Ø 71			1 CP
6		14XLWRINCI	rullo rinvio cinghia belt pulley Walze für Riemen-Rückkehr rouleau de renvoi sangle rodillo correa de transmisión transmissão da correia rolo			1 PZ
7		14XLWGUIL5000 14XLWGUIL6000 14XLWGUIL7000	guida e terminale da vinci da vinci guide and terminal profile Da Vinci Führung und Ende-Ausfallprofil guide et barre de charge da vinci guía y terminal da vinci guia e terminal da vinci		500 cm 600 cm 700 cm	1 PZ
8		14XLWFRTRL4650 14XLWFRTRL5750 14XLWFRTRL7000	frangitratta trasversale da vinci da vinci transverse windbreake durchquerender Windschott Da Vinci brise-vent transversal da vinci cortavientos transversal da vinci disjuntor cruzado da vinci		465 cm 575 cm 700 cm	1 PZ
9		14XLWTAFRO	tappo frontale da vinci da vinci front cap Da Vinci Vorder-Deckel bouchon frontal da vinci capuchón frontal da vinci tampa frontal da vinci			1 PZ
10		14XLWFRVEL5000 14XLWFRVEL7000	frangitratta verticale da vinci da vinci vertical windbreake vertikaler Windschott Da Vinci brise-vent vertical da vinci cortavientos vertical da vinci disjuntor verticais da vinci		500 cm 700 cm	1 PZ

N°						
11		14XLWSPROL	supporto profilo laterale da vinci da vinci lateral profile support Da Vinci-Seitenprofilsstütz support profil latéral da vinci soporte perfil lateral Da Vinci apoio perfil lateral da vinci		1 CP	
12		14XLWCARR	carrello di scorrimento da vinci da vinci sliding trolley Gleitschlitten Da Vinci chariot à roulement da vinci carro de deslizamiento da vinci carrinho de rolagem da vinci		1 PZ	
13		14XLWCURLA	curva laterale da vinci da vinci lateral bend Da Vinci seitliche Kurve coude latéral da vinci curva lateral da vinci lado curva da vinci		1 CP	
14		14XLWFASCL4650 14XLWFASCL5750 14XLWFASCL6800	profilo fascione anteriore da vinci da vinci front band profile Da Vinci Vorderbinde-Profil profil bandeau antérieur perfil faja delantera da vinci perfil frontal de fáschia da vinci		465 cm 575 cm 680 cm	1 PZ
15		14XLWPIE	piedino con rullo da vinci da vinci foot with roll Da Vinci Füßchen mit Rollen pied avec rouleau da vinci pie con rodillos da vinci pé com rolo da vinci		1 PZ	
16		14XLWCIN	cinghia per da vinci 20x0,9 20x0.9 belt for da vinci Da Vinci Riemen 20x0,9 sangle pour da vinci 20x0,9 correa para da vinci 20x0,9 correia da vinci 20x0,9		1 ML	
17		14XLWSCEPL	staffa centrale da vinci plurimodulo da vinci multi-module central support Zentralhalter für Da Vinci Merfach-Module support central module multiple da vinci soporte central da vinci varios módulos suporte central da vinci plurimodulo		1 PZ	
18		14XLWCURNTR	curva centrale da vinci da vinci central bend Zentralkurve Da Vinci coude central da vinci curva céntrica da vinci curva central da vinci		1 PZ	
19		14XLWGIUN	giunzione 40x40 per frontale da vinci 40x40 da vinci frontal bar joint Kupplung 40x40 für Da Vinci Vorderbinde-Profil jonction 40x40 pour barre frontale da vinci brida 40X40 para la parte delantera da vinci junção de 40x40 dianteira da vinci			1 PZ
20		14XLRIVET	rivetto 4,8x10 4.8x10 rivet Niete 4,8x10 rivet 4,8x10 remache 4,8x10 rebite 4,8x10		1 PZ	

N°						€
21		14XLTEFRAL4000 14XLTEFRAL5000 14XLTEFRAL6000 14XLTEFRAL7000	tubo frangivento Ø 70 Ø 70 windbreaker tube Windbrecher-Rohr Ø 70 tube brise-vent Ø 70 tubo cortaviento Ø 70 tubo quebra-vento Ø 70		400 cm 500 cm 600 cm 700 cm	1 PZ
22		2XL911PT7	calotta in nylon Ø 70 perno tondo 12x20 Ø 70 nylon cap with 12x20 round pin Nylon-Wellenkapsel Ø 70 mit 12x20 mm Rundstift calotte en nylon Ø 70 pivot rond 12x20 casquillo de nylon Ø 70 perno redondo 12x20 calote em nylon Ø 70 eixo redondo 12x20			1 PZ
23		GIUN3	giunzione per tubo avvolgitore Ø 78 Ø 78 joint roller tube support Tuchwellen Kupplung Ø 78 jonction Ø 78 support tube enrouleur junta para tubo de enrolle Ø 78 junção para tubo enrolador Ø 78			1 PZ
24		GIUN4	giunzione per tubo avvolgitore Ø 70 Ø 70 joint roller tube support Tuchwellen Kupplung Ø 70 jonction Ø 70 support tube enrouleur junta para tubo de enrolle Ø 70 junção para tubo enrolador Ø 70			1 PZ
25		14XLWGH	ghiere Ø 71 per staffa centrale da vinci PL Ø 71 threaded nut for da vinci multi-module central support Ringe Ø 71 für Da Vinci PL Zentralhalter embout Ø 71 pour support central module multiple da vinci anillos Ø 71 para soporte central da vinci PL mostradores Ø 71 para suporte central			1 CP

DA VINCI COVER

sporgenza max
max projection
maximale Ausladung
avancée maximale
salida máx
saliência máxima

600 cm

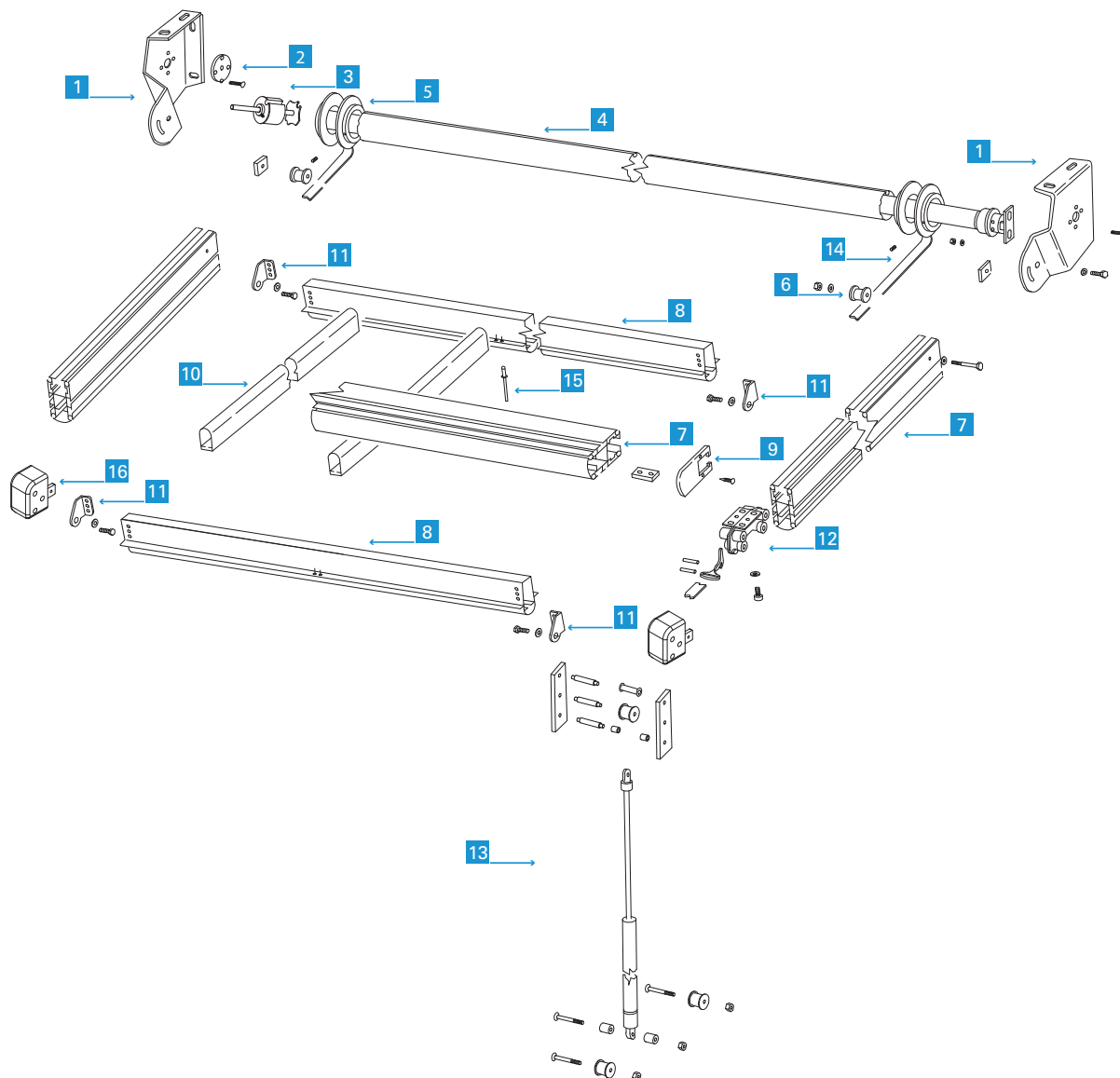

N°						€
1		14XLWLSMO	<p>staffa laterale da vinci da vinci lateral bracket Seitenklammer zur Da Vinci Markise étrier latéral pour da vinci soporte lateral del da vinci suporte lateral da vinci</p>		1 CP	
2		14XLWBOAC	<p>boccola in acetilica Ø 12x70 Ø 12x70 acetalic bushes Acetal-Hülse Ø 12x70 douille acétal Ø 12x70 buje de acetilica Ø 12x70 acetal bucha Ø 12x70</p>		1 PZ	
3		15XLCPT85	<p>calotta in alluminio 85 Ø perno tondo regolabile 85 Ø Aluminium cap with adjustable round pin einstellbarer Aluminiumdeckel Ø 85 Rundstift calotte en aluminium 85 Ø pivot rond réglable tapa de aluminio Ø 85 pines redondo regulable tampa de alumínio Ø 85 pino redondo ajustável</p>		1 PZ	
4		RULA85X12/10L5000 RULA85X12/10L6000	<p>tubo avvolgitore 85 Ø (10/10) Ø 85 roller tube (10/10) Tuchwelle Ø 85 (10/10) tube enrouleur 85 Ø (10/10) tubo de enrolla 85 Ø (10/10) tubo enrolador 85 Ø(10/10)</p>		500 cm 600 cm	1 PZ
5		14XLWGH85	<p>ghiere Ø 85 per guida cinghia 85 Ø threaded nut for belt guide Ringe Ø 85 für Riemen-Führung embout Ø 85 pour guide sangle anillos Ø 85 para guía de correa mostradores Ø 85 para condução de correa</p>		1 CP	
6		14XLWRINCI	<p>rullo rinvio cinghia belt pulley Walze für Riemen-Rückkehr rouleau de renvoi sangle rodillo correa de transmisión transmissão da correa rolo</p>		1 PZ	
7		14XLWGUIL5000 14XLWGUIL6000 14XLWGUIL7000	<p>guida e terminale da vinci da vinci guide and terminal profile Da Vinci Führung und Ende-Ausfallprofil guide et barre de charge da vinci guía y terminal da vinci guia e terminal da vinci</p>		500 cm 600 cm 700 cm	1 PZ
8		14XLWFRTRL4650 14XLWFRTRL5750 14XLWFRTRL7000	<p>frangitratta trasversale da vinci da vinci transverse windbreake durchquerender Windschott Da Vinci brise-vent transversal da vinci cortavientos transversal da vinci disjuntor cruzado da vinci</p>		465 cm 575 cm 700 cm	1 PZ
9		14XLWTAFRO	<p>tappo frontale da vinci da vinci front cap Da Vinci Vorder-Deckel bouchon frontal da vinci capuchón frontal da vinci tampa frontal da vinci</p>		1 PZ	
10		14XLWFRVEL5000 14XLWFRVEL7000	<p>frangitratta verticale da vinci da vinci vertical windbreake vertikaler Windschott Da Vinci brise-vent vertical da vinci cortavientos vertical da vinci disjuntor verticais da vinci</p>		500 cm 700 cm	1 PZ







N°						€
11		14XLWSPROL	<p>supporto profilo laterale da vinci</p> <p>da vinci lateral profile support</p> <p>Da Vinci-Seitenprofilsstütz</p> <p>support profil latéral da vinci</p> <p>soporte perfil lateral Da Vinci</p> <p>apoio perfil lateral da vinci</p>		1 CP	
12		14XLWCARR	<p>carrello di scorrimento da vinci</p> <p>da vinci sliding trolley</p> <p>Gleitschlitten Da Vinci</p> <p>chariot à roulement da vinci</p> <p>carro de deslizamiento da vinci</p> <p>carrinho de rolagem da vinci</p>		1 PZ	
13		14XLWMOGA80 14XLWMOGA105	<p>gruppo molla a gas</p> <p>gas spring with components</p> <p>Gasfeder-Gruppe</p> <p>ressort à gaz avec composants</p> <p>grupo resorte de gas</p> <p>grupo mola a gás</p>	80 cm 105 cm	1 PZ	
14		14XLWCIN	<p>cinghia per da vinci 20x0,9</p> <p>20x0.9 belt for da vinci</p> <p>Da Vinci Riemen 20x0,9</p> <p>sangle pour da vinci 20x0,9</p> <p>correa para da vinci 20x0,9</p> <p>correia da vinci 20x0,9</p>		1 ML	
15		14XLRIVET	<p>rivetto 4,8x10</p> <p>4.8x10 rivet</p> <p>Niete 4,8x10</p> <p>rivet 4,8x10</p> <p>remache 4,8x10</p> <p>rebite 4,8x10</p>		1 PZ	
16		14XLWRIN	<p>rinvio copertura da vinci</p> <p>return for coverage da vinci</p> <p>Verlegung für Da Vinci Deckung</p> <p>renvoi couverture da vinci</p> <p>pieza para cobertura da vinci</p> <p>pieza para cobertura da vinci</p>		1 PZ	

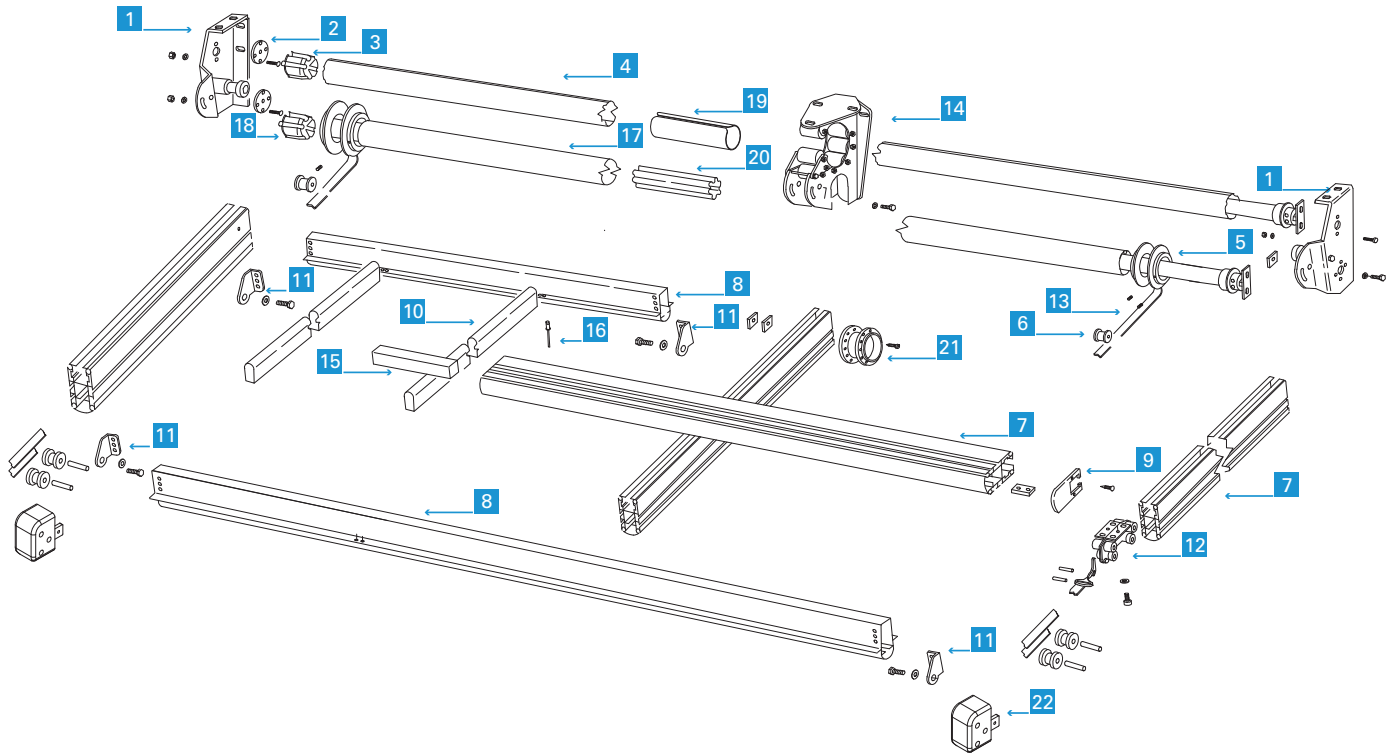



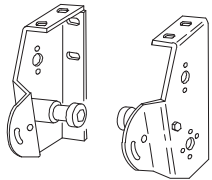
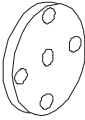
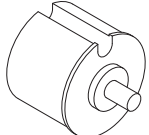
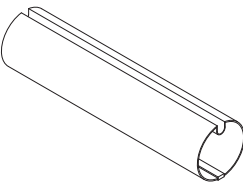
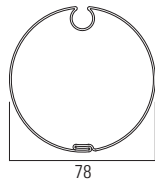
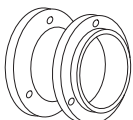
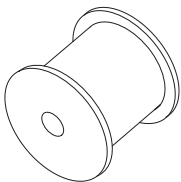

DA VINCI COVER PL

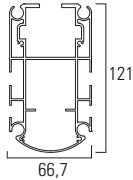
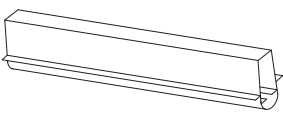
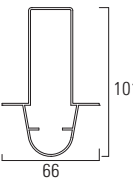
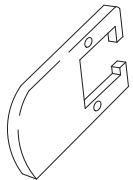
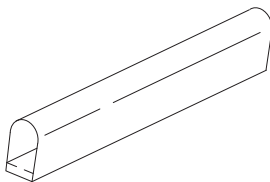
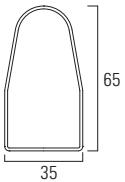

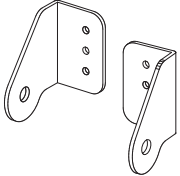
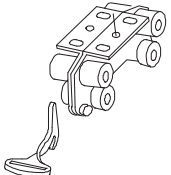
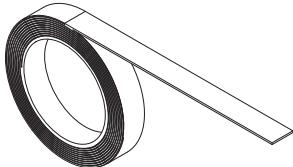
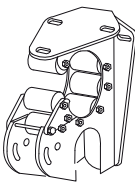
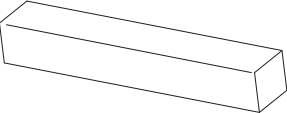
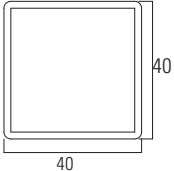

sporgenza max
max projection
maximale Ausladung
avancée maximale
salida máx
saliência máxima

600 cm

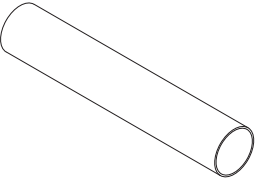
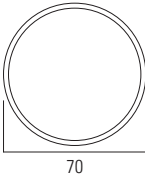
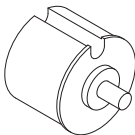
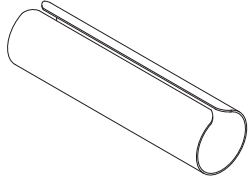
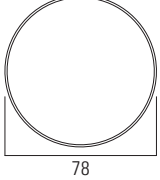
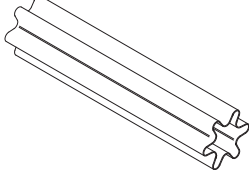
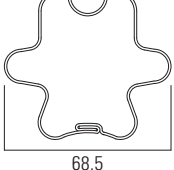

N°					€
1		14XLWSLPL	staffa laterale da vinci plurimodulo da vinci multi-module lateral bracket Seitenklammer zur Da Vinci Merfach-Module étrier latéral pour module multiple da vinci soporte lateral del da vinci varios módulos suporte lateral da vinci plurimodulo		1 CP
2		14XLWBOAC	boccola in acetilica Ø 12x70 Ø 12x70 acetalic bushes Acetal-Hülse Ø 12x70 douille acétal Ø 12x70 buje de acetilica Ø 12x70 acetal bucha Ø 12x70		1 PZ
3		2XL912PT78	calotta in nylon Ø 78 perno tondo 12x20 Ø 78 nylon cap with 12x20 round pin Nylon-Wellenkapsel Ø 78 mit 12x20 mm Rundstift calotte en nylon Ø 78 pivot rond 12x20 casquillo de nylon Ø 78 perno redondo 12x20 calote em nylon Ø 78 eixo redondo 12x20		1 PZ
4		RULA78X10/10L4000 RULA78X10/10L5000 RULA78X10/10L6000 RULA78X10/10L7000	tubo avvolgitore Ø 78 (10/10) Ø 78 roller tube (10/10) Tuchwelle Ø 78 (10/10) tube enrouleur Ø 78 (10/10) tubo de enrollar Ø 78 (10/10) tubo enrolador Ø 78 (10/10)		400 cm 500 cm 600 cm 700 cm
5		14XLWGH71	ghiere Ø 71 Ø 71 threaded nut Ringe Ø 71 embout Ø 71 anillos Ø 71 mostradores Ø 71		1 CP
6		14XLWRINCI	rullo rinvio cinghia belt pulley Walze für Riemen-Rückkehr rouleau de renvoi sangle rodillo correa de transmisión transmissão da correia rolo		1 PZ
7		14XLWGUIL5000 14XLWGUIL6000 14XLWGUIL7000	guida e terminale da vinci da vinci guide and terminal profile Da Vinci Führung und Ende-Ausfallprofil guide et barre de charge da vinci guía y terminal da vinci guia e terminal da vinci		500 cm 600 cm 700 cm
8		14XLWFRTRL4650 14XLWFRTRL5750 14XLWFRTRL7000	frangitratta trasversale da vinci da vinci transverse windbreake durchquerender Windschott Da Vinci brise-vent transversal da vinci cortavientos transversal da vinci disjuntor cruzado da vinci		465 cm 575 cm 700 cm
9		14XLWTAFRO	tappo frontale da vinci da vinci front cap Da Vinci Vorder-Deckel bouchon frontal da vinci capuchón frontal da vinci tampa frontal da vinci		1 PZ
10		14XLWFRVEL5000 14XLWFRVEL7000	frangitratta verticale da vinci da vinci vertical windbreake vertikaler Windschott Da Vinci brise-vent vertical da vinci cortavientos vertical da vinci disjuntor verticais da vinci		500 cm 700 cm

N°					€	
11		14XLWSPROL	supporto profilo laterale da vinci da vinci lateral profile support Da Vinci-Seitenprofilsstütz support profil lateral da vinci soporte perfil lateral Da Vinci apoio perfil lateral da vinci		1 CP	
12		14XLWCARR	carrello di scorrimento da vinci da vinci sliding trolley Gleitschlitten Da Vinci chariot à roulement da vinci carro de deslizamiento da vinci carrinho de rolagem da vinci		1 PZ	
13		14XLWCIN	cinghia per da vinci 20x0,9 20x0.9 belt for da vinci Da Vinci Riemen 20x0,9 sangle pour da vinci 20x0,9 correa para da vinci 20x0,9 correia da vinci 20x0,9		1 ML	
14		14XLWSCEPL	staffa centrale da vinci plurimodulo da vinci multi-module central support Zentralhalter für Da Vinci Merfach-Module support central module multiple da vinci soporte central da vinci varios módulos suporte central da vinci plurimodulo		1 PZ	
15		14XLWGIUN	giunzione 40x40 per frontale da vinci 40x40 da vinci frontal bar joint Kupplung 40x40 für Da Vinci Vorderbinde-Profil jonction 40x40 pour barre frontale da vinci brida 40X40 para la parte delantera da vinci junção de 40x40 dianteira da vinci		1 PZ	
16		14XLRIVET	rivetto 4,8x10 4.8x10 rivet Niete 4,8x10 rivet 4,8x10 remache 4,8x10 rebite 4,8x10		1 PZ	
17		14XLTEFRAL4000 14XLTEFRAL5000 14XLTEFRAL6000 14XLTEFRAL7000	tubo frangivento Ø 70 Ø 70 windbreaker tube Windbrecher-Rohr Ø 70 tube brise-vent Ø 70 tubo cortaviento Ø 70 tubo quebra-vento Ø 70		400 cm 500 cm 600 cm 700 cm	1 PZ
18		2XL911PT7	calotta in nylon Ø 70 perno tondo 12x20 Ø 70 nylon cap with 12x20 round pin Nylon-Wellenkapsel Ø 70 mit 12x20 mm Rundstift calotte en nylon Ø 70 pivot rond 12x20 casquillo de nylon Ø 70 perno redondo 12x20 calote em nylon Ø 70 eixo redondo 12x20		1 PZ	
19		GIUN3	giunzione per tubo avvolgitore Ø 78 Ø 78 joint roller tube support Tuchwellen Kupplung Ø 78 jonction Ø 78 support tube enrouleur junta para tubo de enrolle Ø 78 junção para tubo enrolador Ø 78		1 PZ	
20		GIUN4	giunzione per tubo avvolgitore Ø 70 Ø 70 joint roller tube support Tuchwellen Kupplung Ø 70 jonction Ø 70 support tube enrouleur junta para tubo de enrolle Ø 70 junção para tubo enrolador Ø 70		1 PZ	

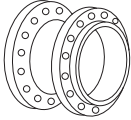
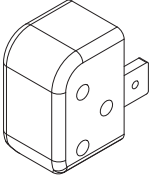
N°						€
21		14XLWGH	<p>ghiere Ø 71 per staffa centrale da vinci PL Ø 71 threaded nut for da vinci multi-module central support Ringe Ø 71 für Da Vinci PL Zentralhalter embout Ø 71 pour support central module multiple da vinci anillos Ø 71 para soporte central da vinci PL mostradores Ø 71 para soporte central</p>		1 CP	
22		14XLWRIN	<p>rinvio copertura da vinci return for coverage da vinci Verlegung für Da Vinci Deckung renvoi couverture da vinci pieza para cobertura da vinci pieza para cobertura da vinci</p>		1 PZ	





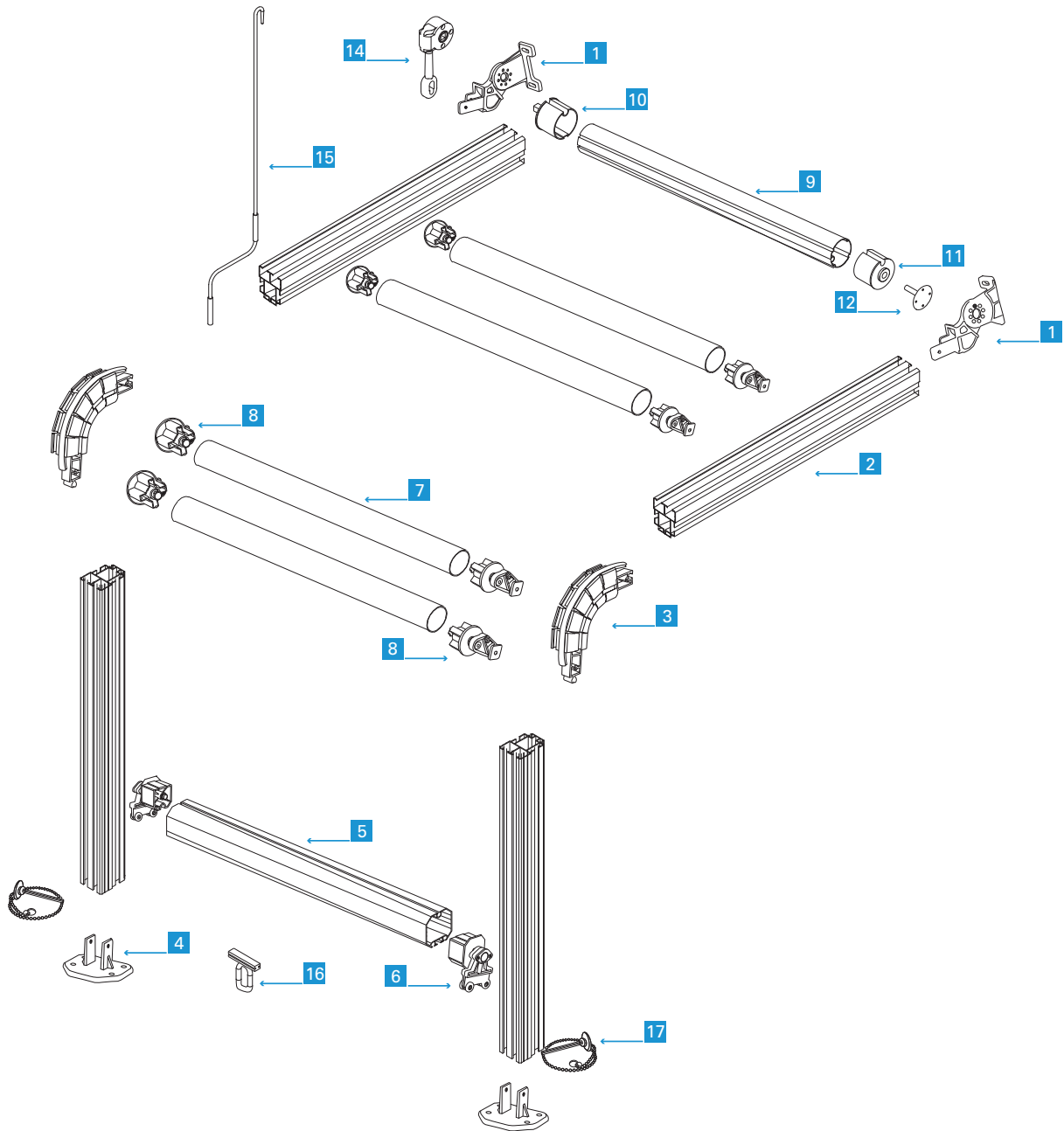
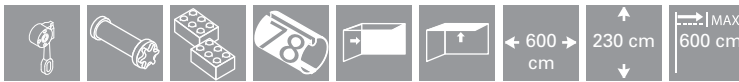

BRUNELLESCHI

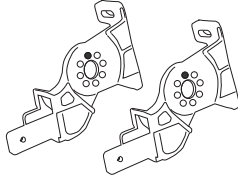
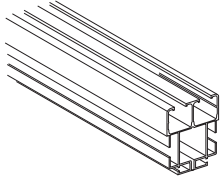
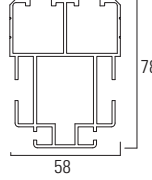
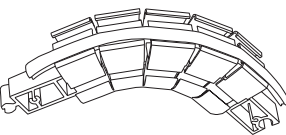
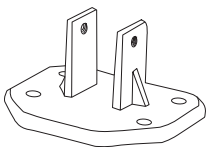
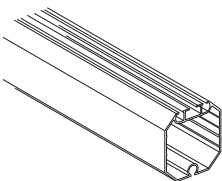
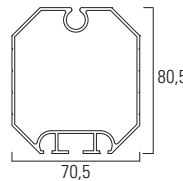
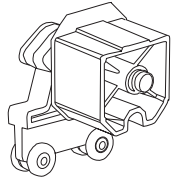
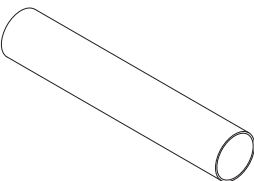
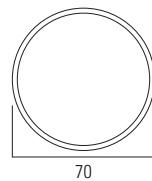
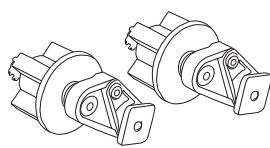
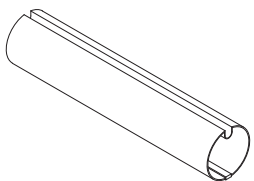
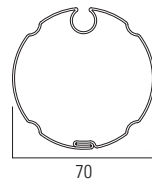
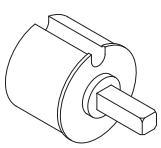
sporgenza max
max projection
maximale Ausladung
avancée maximale
salida máx
saliência máxima

600 cm

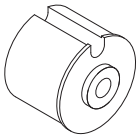
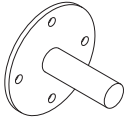

N°								
1		13XLSTA	<p>staffe ed innesti brunelleschi</p> <p>brunelleschi bracket and graft</p> <p>Brunelleschi Befestigungsklammern und Verkeilungen</p> <p>étrier et insert brunelleschi</p> <p>soportes y empalmes brunelleschi</p> <p>estribos e acoplamentos brunelleschi</p>					1 CP
2		13XLGUIL4000 13XLGUIL5000 13XLGUIL6000 13XLGUIL7000	<p>profilo guida brunelleschi</p> <p>brunelleschi guide profile</p> <p>Führungsprofil Brunelleschi</p> <p>guidage brunelleschi</p> <p>perfil guía brunelleschi</p> <p>perfil guia brunelleschi</p>		400 cm 500 cm 600 cm 700 cm			1 PZ
3		13XLCUR	<p>curva brunelleschi</p> <p>brunelleschi bend</p> <p>Kurve Brunelleschi</p> <p>coude brunelleschi</p> <p>curva brunelleschi</p> <p>curva brunelleschi</p>					1 PZ
4		13XLPIE	<p>pieдино brunelleschi</p> <p>brunelleschi foot</p> <p>Bodenbefestigung Brunelleschi</p> <p>ped brunelleschi</p> <p>base brunelleschi</p> <p>pé brunelleschi</p>					1 PZ
5		13XLTEOTL4000 13XLTEOTL5000 13XLTEOTL6000 13XLTEOTL7000	<p>terminale ottagonale brunelleschi</p> <p>brunelleschi octagonal terminal</p> <p>Achteckiges Brunelleschi Anschlussprofil</p> <p>barre de charge octogonal brunelleschi</p> <p>barra de carga octogonal brunelleschi</p> <p>terminal octagonal brunelleschi</p>		400 cm 500 cm 600 cm 700 cm			1 PZ
6		13XLCAR	<p>carrello con tappo terminale</p> <p>trolley with cap</p> <p>Wälzkarren mit Verschlussdeckel</p> <p>chairiot avec bouchon</p> <p>carro con tapa barra de carga</p> <p>carrinho com tampa terminal</p>					1 PZ
7		14XLTEFRAL4000 14XLTEFRAL5000 14XLTEFRAL6000 14XLTEFRAL7000	<p>tubo frangivento Ø 70</p> <p>Ø 70 windbreaker tube</p> <p>Windbrecher-Rohr Ø 70</p> <p>tube brise-vent Ø 70</p> <p>tubo cortaviento Ø 70</p> <p>tubo quebra-vento Ø 70</p>		400 cm 500 cm 600 cm 700 cm			1 PZ
8		13XLTATU	<p>tappo frangivento Ø 70</p> <p>Ø 70 windbreaker cap</p> <p>Windbrecherdeckel Ø 70</p> <p>bouchon brise-vent Ø 70</p> <p>tapa cortaviento Ø 70</p> <p>tampa quebra-ventol Ø 70</p>					1 CP
9		RULA70X10/10L4000 RULA70X10/10L5000 RULA70X10/10L6000 RULA70X10/10L7000	<p>tubo avvolgitore Ø 70 (10/10)</p> <p>Ø 70 roller tube (10/10)</p> <p>Tuchwelle Ø 70 (10/10)</p> <p>tube enrouleur Ø 70 (10/10)</p> <p>tubo de enrollle Ø 70 (10/10)</p> <p>tubo enrolador Ø 70 (10/10)</p>		400 cm 500 cm 600 cm 700 cm			4 PZ
10		2XL911PQ7	<p>calotta in nylon Ø 70 perno quadro 13x40</p> <p>Ø 70 nylon cap with 13x40 square pin</p> <p>Nylon-Wellenkapsel Ø 70 mit 13x40mm Vierkantstift</p> <p>calotte en nylon Ø 70 pivot carré 13x40</p> <p>casquillo de nylon Ø 70 perno cuadrado 13x40</p> <p>calote em nylon Ø 70 eixo quadrado 13x40</p>					1 PZ

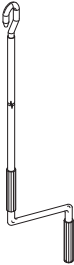
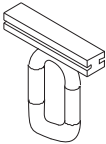
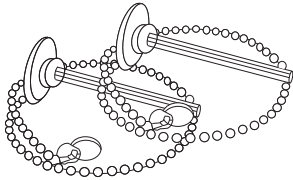
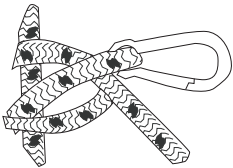
N°					€
11		2XL910F7	calotta in nylon Ø 70 foro tondo Ø 70 nylon cap with round hole Wellenkapsel mit Rundstift Ø 70 calotte en nylon Ø 70 trou rond casquillo de nylon Ø 70 agujero redondo calota em nylon Ø70 furo redondo	1 PZ	
12		PIVOT	pivot pin Plättchen mit Stift pivot pivotte pivô	1 PZ	
14		PFARG11/1	arganello 11/1 reduction winch 11/1 Wunsch 11/1 treuil 11/1 máquina sinfín 11/1 sarilho 11/1	1 PZ	
15		PFASM100 PFASM120 PFASM150 PFASM180 PFASM200 PFASM220 PFASM250 PFASM300	asta manovra crank rod Bedienungsstange manivelle manivela manivela	100 cm 120 cm 150 cm 180 cm 200 cm 220 cm 250 cm 300 cm	10 PZ
16		13XLOC	occhiolo per terminale brunelleschi runner for brunelleschi terminal bar Bügel für Brunelleschi Anschlussprofil oillet pour barre ce charge brunelleschi ojal barra de carga brunelleschi grampo para terminal brunelleschi	1 PZ	
17		13XLFER	fermo per terminale lock for terminal bar Verschluss für Ende-Ausfallprofil bloc pour le terminal tope para barra de carga parada para barra terminal	1 CP	
		13XLFU	fune con moschettone rope with spring clip Seil mit Karabinerhaken cordage avec mousqueton cuerda con mosquetón cabo com fecho	1 PZ	



EXTRA COMPONENTS FOR BRUNELLESCHI PL

componenti aggiuntivi per brunelleschi PL
extra components for brunelleschi PL

optionale Zubehöre für Brunelleschi PL
composant optionnels pour brunelleschi PL

complementos adicionales para brunelleschi PL
complementos extra ao brunelleschi PL

	<p>13XLSTAPL</p>	<p>staffe ed innesti brunelleschi PL support and joints brunelleschi PL Haltern und Anschlüsse Brunelleschi PL étriers et greffons brunelleschi PL soporte y juntas de brunelleschi PL apoios e junções de brunelleschi PL</p>	<p>1 CP</p>	
	<p>13XLSPEPL</p>	<p>spessore per brunelleschi PL spacer for brunelleschi PL Abstandhalter für Brunelleschi PL écarteur pour brunelleschi PL separador para brunelleschi PL espaçador de pared de brunelleschi PL</p>	<p>1 CP</p>	
	<p>13XLSUPCE</p>	<p>supporto centrale brunelleschi brunelleschi central support zentral Ausgleichsstütz Brunelleschi support central brunelleschi soporte central brunelleschi suporte central brunelleschi</p>	<p>1 PZ</p>	
	<p>13XLCACER</p>	<p>carrello centrale brunelleschi brunelleschi central trolley zentrale Wälzkarre Brunelleschi support central brunelleschi carro central brunelleschi carrinho central brunelleschi</p>	<p>1 PZ</p>	

AVAILABLE COLOURS

	RAL9010	RAL7035	RAL1013	OTHER RAL
DA VINCI	STANDARD	to be quoted	to be quoted	to be quoted
DA VINCI PL	STANDARD	to be quoted	to be quoted	to be quoted
DA VINCI COVER	STANDARD	to be quoted	to be quoted	to be quoted
DA VINCI COVER PL	STANDARD	to be quoted	to be quoted	to be quoted
BRUNELLESCHI	STANDARD	to be quoted	to be quoted	to be quoted

RAL: ALTRI | OTHER | ANDERE | AUTRES | OTROS | OUTROS

preventivo - quote - Angebot - devis - presupuesto - cotação



tende a bracci
su barra quadrata

Gelenkarmmarkisen
auf Vierkant-Tragrohr

toldos con brazos
sobre barra cuadrada

folding arm awnings
on square bar

stores a bras
articulés sur barre carrée

toldos com braços
sobre barra quadrada



tende a bracci
su staffe indipendenti

Tragrohrlose Markisen auf
unabhängige Armträger

toldos con brazos sobre
soportes independientes

folding arm awnings
on independent brackets

stores à bras en
étriers indépendants

toldos com braços sobre
estribos independentes



tende a bracci
con cassonetto

Kassettenmarkisen

toldos con brazos
con cajón

folding arm awnings
with cassette

stores à bras
avec coffre

toldos com braços
e caixote



tende a caduta

Fallarm Markisen

toldos de caída

drop awnings

stores à descente

toldos enroscáveis



tende per veranda

Terrassenbeschattungen

toldos para terrazas

veranda awnings

stores pour vérandas

toldos para varandas



cappottine

Korbmarkisen

capotas

canopies

corbeilles

capotes



gamma bracci &
accessori

Gelenkarme und
Zubehöre-Serie

gama brazos y
accesorios

arms' &
components' range

gamme de bras &
accessoires

gama braços &
acessórios



euroflex A TOUCH OF SHADE

euroflex srl

via pacinotti, 14 | 35030

rubano (padova) Italia

T +39 049 629588

T +39 049 8933183

F +39 049 629703

info@euroflex.cc

www.euroflex.cc

FLEX PRICE MOLIÈRE