

A TOUCH OF SHADE

WHY
NOT
?

eurolflex 

DROP AWNINGS

FLEX PRICE CAMÕES

TENDE A CADUTA

drop awnings
Fallarm Markisen
stores à descente
toldos de caída
toldos enroscáveis

sistemi	systems	Systeme	systèmes	sistemas	sistemas
componenti	components	Komponenten	composants	componentes	componentes
accessori	accessories	Zubehöre	accessoires	accesorios	acessórios
per tende	for	für	pour bannes	para	para
da sole	awnings	Markisen	stores	toldos	toldos

 con tettuccio with hood mit Schutzdach avec auvent con tejadillo com telhado	 con guscio with cassette - guscio mit Gehäuse - guscio avec coffre - guscio com cofre-guscio com caja-guscio	 bracci sovrapponibili crossing arm system Arme-Senkvorrichtung kit abaissement bras kit bajando brazo kit redusáu braço	 modulare modular modulierbar moduler modular modular
 con arganello with reduction winch mit Wunsch avec treuil con máquina sinfín com sarilho	 con motore with motor mit Motor avec moteur con motor com motor	 terminale leggero light terminal bar leichtes Ausfallprofil barre de charge légère barra de carga ligera barra terminal leve	 terminale pesante heavy terminal bar schweres Ausfallprofil barre de charge lourde barra de carga pesada barra terminal pesada
 tubo avvolgitore Ø 60 Ø 60 roller tube Tuchwelle Ø 60 tube enrouleur Ø 60 tubo de enrollo Ø 60 tubo enrolador Ø 60	 tubo avvolgitore Ø 70 Ø 70 roller tube Tuchwelle Ø 70 tube enrouleur Ø 70 tubo de enrollo Ø 70 tubo enrolador Ø 70	 tubo avvolgitore Ø 78 Ø 78 roller tube Tuchwelle Ø 78 tube enrouleur Ø 78 tubo de enrollo Ø 78 tubo enrolador Ø 78	 tubo avvolgitore Ø 85 Ø 85 roller tube Tuchwelle Ø 85 tube enrouleur Ø 85 tubo de enrollo Ø 85 tubo enrolador Ø 85
 installazione parete wall installation Wandmontage dressage au mur instalación pared instalação parede	 installazione soffi tto ceiling installation Deckenmontage dressage plafond instalación techo instalação teto	 installazione laterale lateral installation Seitenmontage dressage latéral instalación lateral instalação lateral	
 altezza max cm max height cm maximale Höhe cm hauteur max cm alto máx cm altura max cm	 larghezza max cm max width cm maximale Breite cm largeur max cm ancho máx cm largura max cm	 sporgenza max cm max projection cm maximale Ausladung cm avancée maximale cm salida máx cm saliência max cm	
 classe 2: sporgenza max cm class 2: max projection cm Klasse 2: max. Ausladung cm classe 2: avancée maximale cm clase 2: salida máx cm classe 2: saliência max cm	 classe 1: sporgenza max cm class 1: max projection cm Klasse 1: max. Ausladung cm classe 1: avancée maximale cm clase 1: salida máx cm classe 1: saliência max cm		

 Per un corretto funzionamento, il supporto per i bracci incrociati può essere usato con un'angolazione massima della tenda di 40°.	Für einen korrekten Betrieb, die gekreuzte Arme-Senkvorrichtung soll mit maximaler 40° Neigung der Markise verwendet werden.	Para una explotación correcta, el soporte para los brazos cruzados debe utilizarse con una inclinación máxima del toldo de 40°.
For a correct operation, the support for crossed arms should be used with a maximum awning angle of 40°.	Pour un bon fonctionnement, le support pour les bras croisés peut être utilisé avec un angle maximal du store de 40°.	Para um funcionamento correcto, o apoio para os braços cruzados deve ser utilizado com uma inclinação máxima del toldo de 40°.

TUTTE LE MISURE DEI BRACCI SONO INTESE PER SPORGENZA TENDA

JEDE DIMENSION DER ARME BEZIEHT SICH AUF DIE MARKISE-AUSLADUNG

TODAS LAS MEDIDAS DE LOS BRAZOS SE ENTIENDEN POR SALIDA DEL TOLDO

ALL ARM DIMENSIONS ARE REFERRED TO THE AWNING PROTECTION

TOUTES LES MESURES DES BRAS SONT ENTENDUES EN CONSIDERANT L'AVANCEE DU STORE

TODAS AS MEDIDAS DOS BRAÇOS SÃO ENTENDIDAS COMO SALIÊNCIA DO TOLDO

 CP = coppia - pair - Paar - paire - pareja - par
PZ = pezzi - pieces - Stück - pièces - pieza - peças
ML = metro lineare - linear meter - Laufmeter - mètre linéaire - metro lineal - metro linear

tenda
awning
Markise
store
toldo
toldo

sporgenza max cm
maximum projection cm
maximale Ausladung cm
avancée maximale cm
salida máx cm
saliência máxima cm

numero pagina
page no.
Seite Nr.
page n°
número de página
página número

GUIDED VERTICAL AWNING

ANTONELLI	140 cm	6
CANALETTO	60 cm	10
BELLINI	---	14

VERTICAL AWNING WITHOUT GUIDE

VANVITELLI	140 cm	18
GUERCINO	100 cm	22

ANTONELLI

altezza max
 max height
 maximale Höhe
 hauteur max
 salida máx
 saliència máxima

340 cm

larghezza max
 max width cm
 Max. Breite cm
 largeur max cm
 ancho máx cm
 largura max cm

480 cm

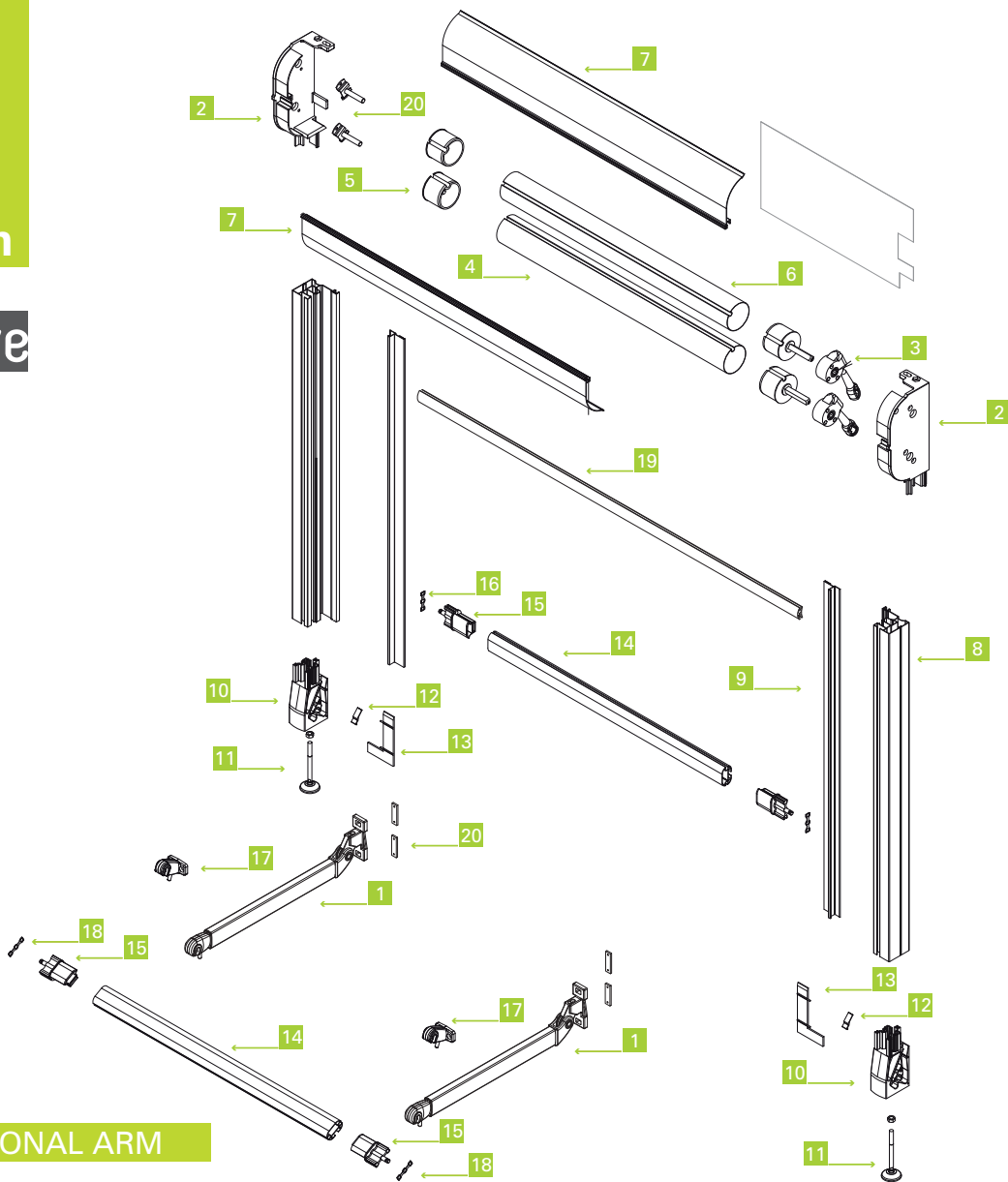



MAIN ARM / OPTIONAL ARM







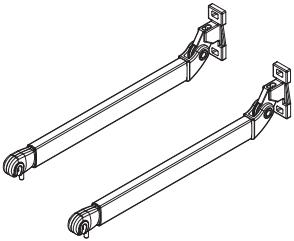
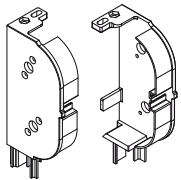

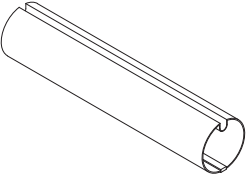
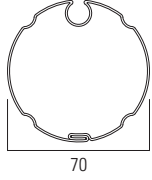
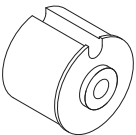
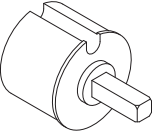
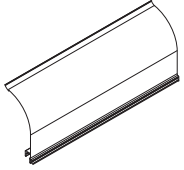
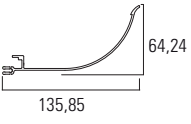
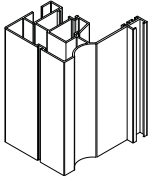
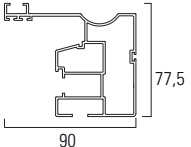
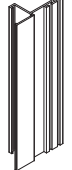
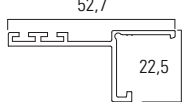
braccio principale
 main arm
 standard Arm
 bras principal
 brazo principal
 braço principal

braccio opzionale
 optional arm
 optionaler Arm
 bras en option
 brazo opcional
 braço opcional

ANTONELLI

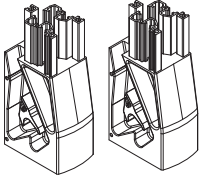
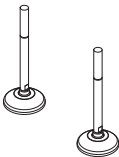
///

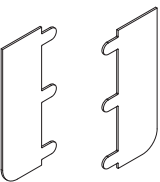
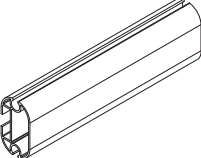
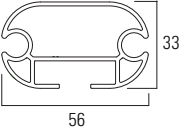
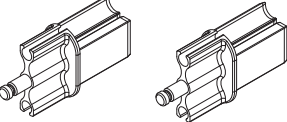
N°						
1		10XLA070 10XLA080 10XLA100 10XLA120 10XLA140	braccio antonelli antonelli arm Gelenkarm Antonelli bras antonelli brazo antonelli braço antonelli	70 cm 80 cm 100 cm 120 cm 140 cm	1 CP	
2		10XLATES	testata antonelli header antonelli Kopfstoß Antonelli tête antonelli cabecera antonelli cabeçada antonelli		1 CP	
3		PFARG11/1	arganello 11/1 reduction winch 11/1 Wunsch 11/1 treuil 11/1 máquina sinfín 11/1 sarilho 11/1		1 PZ	
4		RULA70X10/10L4000 RULA70X10/10L5000 RULA70X10/10L6000 RULA70X10/10L7000	tubo avvolgitore Ø 70 (10/10) Ø 70 roller tube (10/10) Tuchwelle Ø 70 (10/10) tube enrouleur Ø 70 (10/10) tubo de enrollar Ø 70 (10/10) tubo enrolador Ø 70 (10/10)		400 cm 500 cm 600 cm 700 cm	4 PZ
5		2XL910F7	calotta in nylon Ø 70 foro tondo Ø 70 nylon cap with round hole Nylon-Wellenkapsel Ø 70 mit Rundstift calotte en nylon Ø 70 trou rond casquillo en nylon D. 70 agujero redondo calota em nylon d. 70 furo redondo		1 PZ	
6		2XL911PQ7	calotta in nylon Ø 70 perno quadro 13x40 Ø 70 nylon cap with 13x40 square pin Nylon-Wellenkapsel Ø 70 mit 13x40 Vierkantstift calotte en nylon Ø 70 pivot carré 13x40 casquillo en nylon Ø 70 perno cuadrado 13x40 calote em nylon Ø 70 eixo quadrado 13x40		1 PZ	
7		10XLACOPL7000	profilo cassonetto antonelli antonelli cassette profile Kassettenprofil Antonelli profil coffre antonelli perfil cajón antonelli perfil caixote antonelli		700 cm	1 PZ
8		10XLAGUIL5400	guida antonelli antonelli profile guide Führung Antonelli glissière antonelli guía antonelli guia antonelli		540 cm	1 PZ
9		10XLAALGL5400	aletta per guida antonelli antonelli fin for guide Verschlussprofil für Führung Antonelli nageoire pour glissière antonelli aleta por guía antonelli albeta para guía antonelli		540 cm	1 PZ

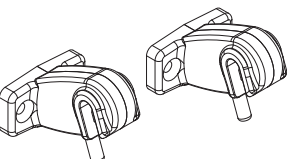
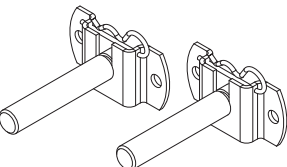
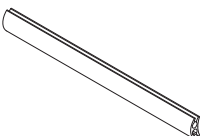
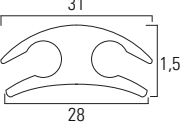
N°						€
10		10XLAPIE	<p>piede antonelli con linguetta antonelli foot with tab Bodenbefestigung Antonelli mit Klappe pied antonelli avec languette pie antonelli con lengüeta pé antonelli com lingueta</p>		1 CP	
11		10XLAPRG	<p>spessore registrabile per piede antonelli adjustable wedge for antonelli foot Keil für Füßchen Antonelli cale régable pour pied antonelli cuña ajustable por pie antonelli cunha Registrável para pé antonelli</p>		1 CP	
12		10XLALID	<p>linguetta di deviazione per piede antonelli deflection lid for antonelli small foot Abweichungs-Klappe für Füßchen Antonelli languette de déviation pour pied antonelli lengüeta de desviación por pie antonelli lingueta de desvio para pé antonelli</p>		1 PZ	
13		10XLAPCP	<p>parete copertura antonelli plate for foot antonelli Plättchen für Füßchen Antonelli plaquette pour pied antonelli plaquita para pie antonelli pratinho para pé antonelli</p>		1 CP	
14		10XLATERL7000	<p>profilo terminale antonelli antonelli terminal bar Ende-Ausfallprofil Antonelli profil barre de charge antonelli perfil barra de carga antonelli perfil terminal antonelli</p>		700 cm	1 PZ
15		10XLATAP	<p>tappo terminale antonelli antonelli caps for terminal bar Stopfen für Endprofil Antonelli bouchon barre de charge antonelli tapón para perfil terminal antonelli tampa de terminal antonelli</p>		1 CP	
16		10XLALRT	<p>lamierino di rinforzo tappo small plate for cap-reinforcement Verstärkungsblech für Deckel feuille de renfort bouchon plaquita de refuerzo tapón pratinho de reforço tampa</p>		1 CP	
17		10XLAPUN	<p>puntale tenda antonelli antonelli tip for terminal bar Spitze für Antonelli Endprofil embout profil terminal Antonelli punta para perfil terminal antonelli gorjeta para terminal antonelli</p>		1 CP	
18		10XLAPIVBLOK	<p>pivot per calotta con foro tondo cap pin with round hole Plättchen mit Stift für Wellenkapsel. Rundloch pivot pour calotte avec trou rond perno por casquillo con agujero redondo pivô para calote com furo redondo</p>		1 CP	
19		10XLASTECL7000	<p>profilo frangitratta antonelli antonelli windbreak profile Antonelli Windschottprofil profil brise-vent antonelli perfil cortavientos antonelli perfil quebra-vento antonelli</p>		700 cm	1 PZ

N°					€
20		2XLPSTBB	<p>piastrina 30X40X8 con vite da 10x25 mm small plate 30x40x8 with 10x25 mm scrub Plättchen 30x40x8 mit 10x25 mm Schraube plaquette 30x40x8 avec vis de 10x25 mm plaquita 30x40x8 con tornillo de 10x25 mm pratinho 30x40x8 com rosca de 10x25 mm</p>	1 PZ	

KIT ANTONELLI

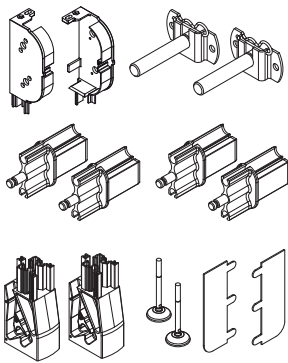

10XLANTKIT	<p>kit antonelli kit antonelli kit Antonelli kit antonelli kit antonelli kit antonelli</p> <p>2+10+11+13 + 15(x2)+18</p>	1 PZ	
------------	---	------	--

CANALETTO

altezza max
 max height
 maximale Höhe
 hauteur max
 salida máx
 saliência máxima

300 cm

larghezza max
 max width cm
 Max. Breite cm
 largeur max cm
 ancho máx cm
 largura max cm

480 cm

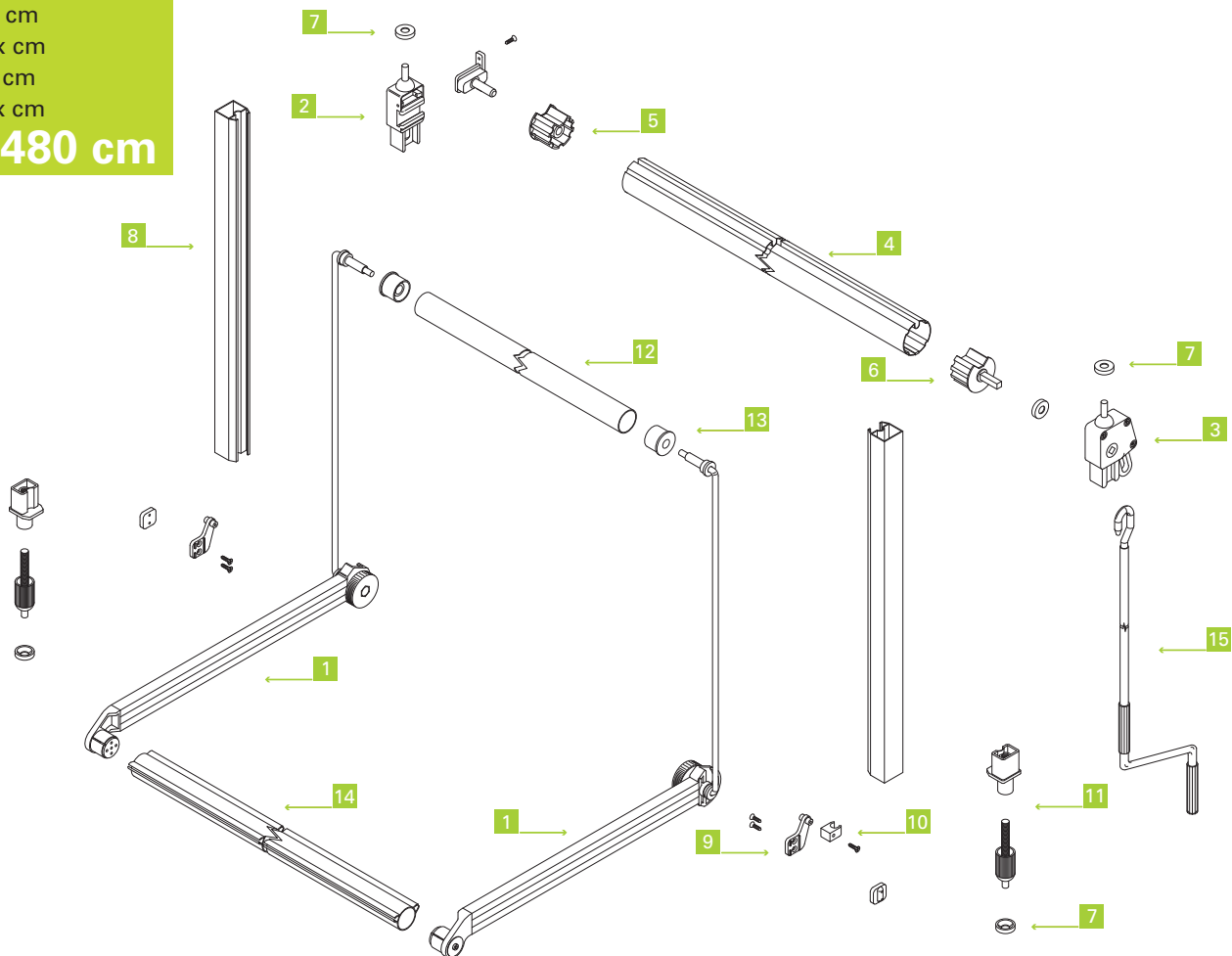



MAIN ARM / OPTIONAL ARM



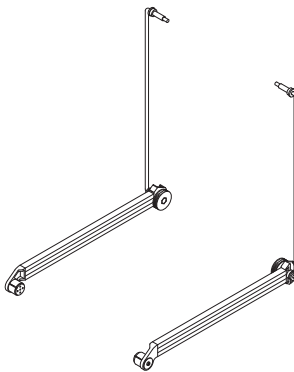
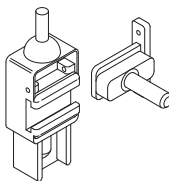
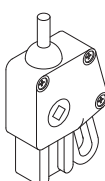
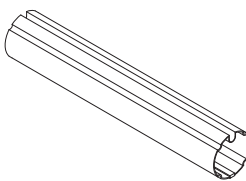
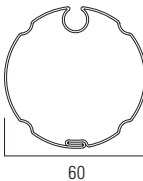
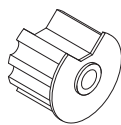
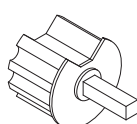
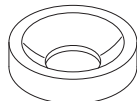

braccio principale
 main arm
 standard Arm
 bras principal
 brazo principal
 braço principal

braccio opzionale
 optional arm
 optionaler Arm
 bras en option
 brazo opcional
 braço opcional

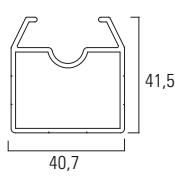
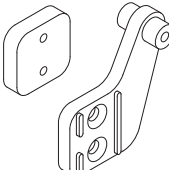
CANALETTO

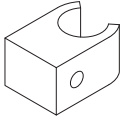
///

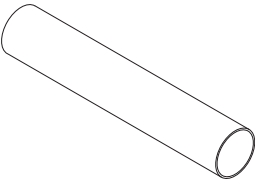
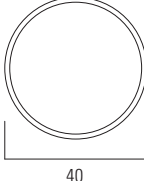
N°						
1		10XL60	braccio canaletto canaletto arm Gelenkarm Canaletto bras canaletto brazo canaletto braço canaletto	60 cm	1 CP	
2		10XLSTP	testata con perno TC TC header with pin Kopfstoß mit Bolzen TC tête avec pivot TC cabecera con perno TC cabeçada antonelli com eixo TC		1 PZ	
3		10XLSA	arganello TC TC reduction winch Wunsch TC support avec treuil TC máquina sinfín TC sarilho TC		1 PZ	
4		RULA60X8/10L7000	tubo avvolgitore Ø 60 Ø 60 roller tube Tuchwelle Ø 60 tube enrouleur Ø 60 tubo de enrollar Ø 60 tubo enrolador Ø 60		700 cm	1 PZ
5		10XLBT6	calotta in nylon Ø 60 foro tondo Ø 60 nylon cap with round hole Nylon-Wellenkapsel Ø 60 mit Rundloch calotte en nylon Ø 60 trou rond casquillo de nylon Ø 60 agujero redondo calota em nylon Ø60 furo redondo		1 PZ	
6		10XLBQ6	calotta in nylon Ø 60 perno quadro Ø 60 nylon cap with square pin Nylon-Wellenkapsel Ø 60 mit Vierkantstift calotte en nylon Ø 60 pivot carré casquillo en nylon Ø 60 perno cuadrado calote em nylon Ø 60 eixo quadrado		1 PZ	
7		10XLRO	rondella pvc TC PVC-waher TC PVC-Dichtungsring TC rondelle pvc TC arandela pvc TC arruela pvc TC		1 PZ	
8		10XLGLATL7000	guida laterale side profile guide Seitenführung Führung glissière latéral guía lateral guia latera		700 cm	3 PZ
9		10XLGR	gruppo arresto stop unit for arms Stopp-Einheit für Arme groupe d'arrêt pour bras unidad de parada para brazos unidade de parada para braços		1 PZ	

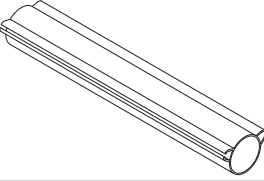
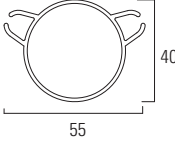
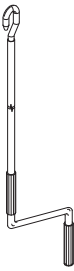
N°							€
10		10XLFE	ferma asta crank rod clic Sperrstück für Bedienungsstange arrêt manivelle pinza sujeta manivela bloca manivela				1 PZ
11		10XLPI	supporto piede regolabile adjustable foot support einstellbarer Stütz für Füßchen support pied réglable soporte pie regulable suporte pés reguláveis				1 PZ
12		10XLFRANL7000	tubo frangivento windbreaker Windbrecherrohr tube brise-vent tubo cortaviento tubo quebra-vento		700 cm	1 PZ	
13		10XLMK	innesto tubo frangivento windbreaker tube joint Kupplung für Winschott-Rohr raccord tube brise-vent empalme tubo cortaviento acoplamiento tubo quebra-vento			1 PZ	
14		10XLTASL7000	terminale asolato slotted terminal bar joint geschlitzte Kupplung für Endprofil jonction rayé barre de charge junta ranurada para terminal junção entalhada para terminais			1 PZ	
15		PFASM100 PFASM120 PFASM150 PFASM180 PFASM200 PFASM220 PFASM250 PFASM300	asta manovra crank rod Bedienungsstange manivelle manivela manivela		100 cm 120 cm 150 cm 180 cm 200 cm 220 cm 250 cm 300 cm	10 PZ	

KIT CANALETTO

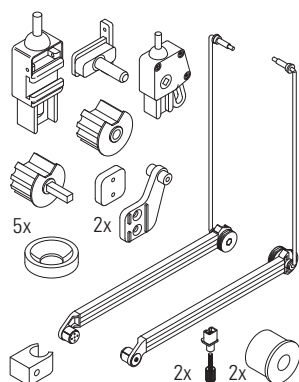

10XLT4

kit canaletto
kit canaletto
kit Canaletto
kit canaletto
kit canaletto

 $1 + 2 + 3 + 5 + 6 + 7(x5) + 9(x2) + 10 + 11(x2) + 13(x2)$

1 PZ

BELLINI







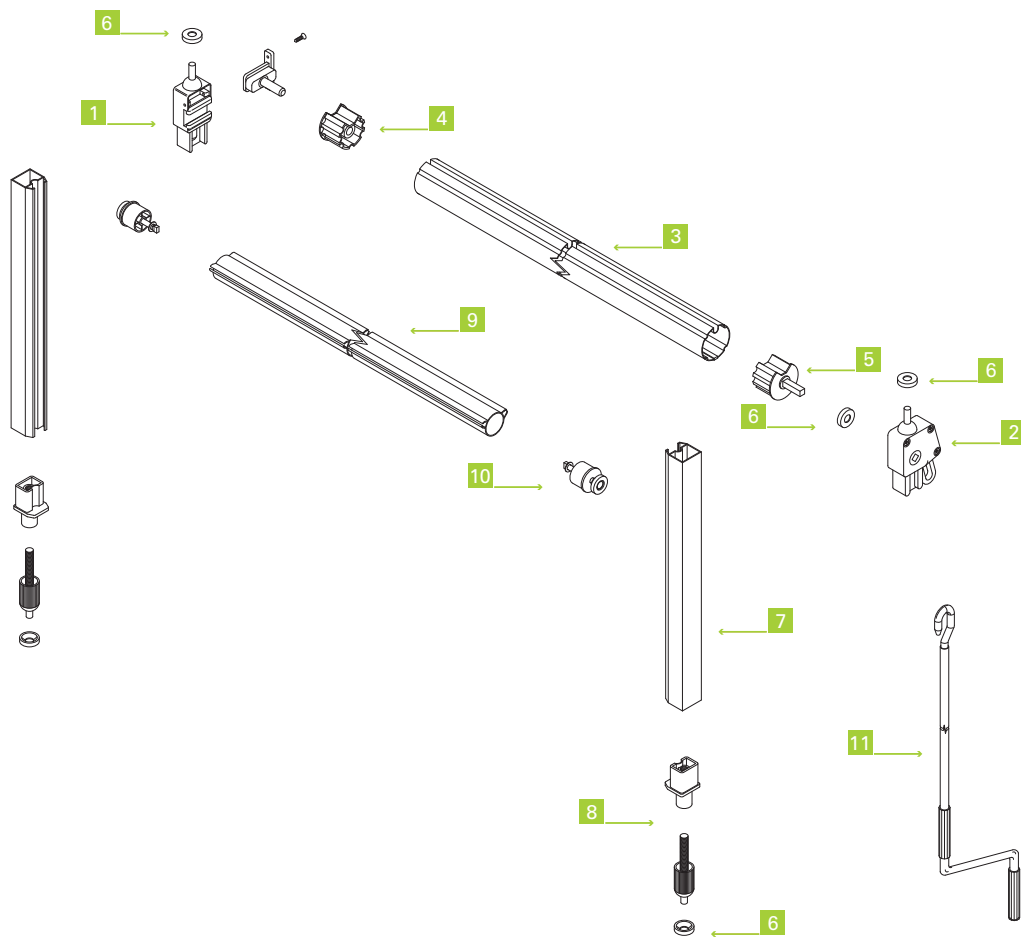

sporgenza max
max projection
maximale Ausladung
avancée maximale
salida máx
saliência máxima

300 cm

larghezza max
max width cm
Max. Breite cm
largeur max cm
ancho máx cm
largura max cm

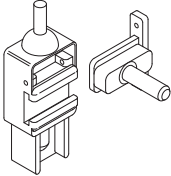
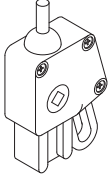
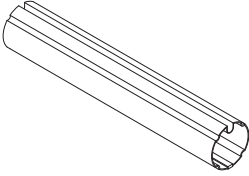
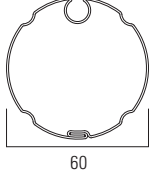
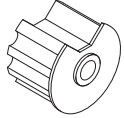
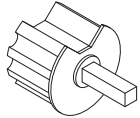
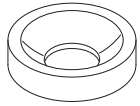
480 cm

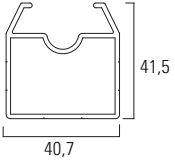

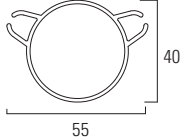
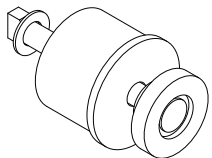
N°					€	
1		10XLSTP	testata con perno TC TC header with pin Kopfstoß mit Bolzen TC tête avec pivot TC cabecera con perno TC cabegada antonelli com eixo TC		1 PZ	
2		10XLSA	arganello TC TC reduction winch Wunsch TC support avec treuil TC máquina sinfín TC sarilho TC		1 PZ	
3		RULA60X8/10L7000	tubo avvolgitore Ø 60 Ø 60 roller tube Tuchwelle Ø 60 tube enrouleur Ø 60 tubo de enrolle Ø 60 tubo enrolador Ø 60		700 cm	1 PZ
4		10XLBT6	calotta in nylon Ø 60 foro tondo Ø 60 nylon cap with round hole Nylon-Wellenkapsel Ø 60 mit Rundloch calotte en nylon Ø 60 trou rond casquillo de nylon Ø 60 agujero redondo calota em nylon Ø60 furo redondo			1 PZ
5		10XLBQ6	calotta in nylon Ø 60 perno quadro Ø 60 nylon cap with square pin Nylon-Wellenkapsel Ø 60 mit Vierkantstift calotte en nylon Ø 60 pivot carré casquillo en nylon Ø 60 perno cuadrado calote em nylon Ø 60 eixo quadrado			1 PZ
6		10XLRO	rondella pvc TC PVC-waher TC PVC-Dichtungsring TC rondelle pvc TC arandela pvc TC arruela PVC TC			1 PZ
7		10XLGLATL7000	guida laterale side profile guide Seitenführung Führung glissière latéral guía lateral guia latera		700 cm	3 PZ
8		10XLPI	supporto piede regolabile adjustable foot support einstellbarer Stütz für Füßchen support pied réglable soporte pie regulable suporte pés reguláveis			1 PZ
9		10XLTASL7000	terminale asolato slotted terminal bar joint geschlitzte Kupplung für Endprofil jonction rayé barre de charge junta ranurada para terminal junção entalhada para terminais			1 PZ
10		10XLIN	innesto terminale asolato con ruote splice with wheels for slotted terminal bar Kupplung mit Räder für geschlitzte Kupplung raccord avec roues pour profil de jonction rayé junta con ruedas para junta ranurada junção con rodas para junção entalhada			1 PZ

N°					€
11		PFASM100 PFASM120 PFASM150 PFASM180 PFASM200 PFASM220 PFASM250 PFASM300	asta manovra crank rod Bedienungsstange manivelle manivela manivela	100 cm 120 cm 150 cm 180 cm 200 cm 220 cm 250 cm 300 cm	10 PZ

KIT BELLINI

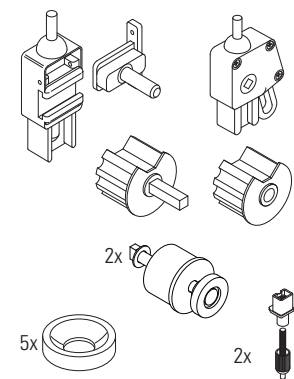

10XLT4SB

kit bellini
 kit bellini
 kit Bellini
 kit bellini
 kit bellini

 $1 + 2 + 4 + 5 + 6(x5) + 8(x2) + 10(x2)$

1 PZ

VANVITELLI

altezza max
 max height
 maximale Höhe
 hauteur max
 salida máx
 saliência máxima

300 cm

larghezza max
 max width cm
 Max. Breite cm
 largeur max cm
 ancho máx cm
 largura max cm

480 cm

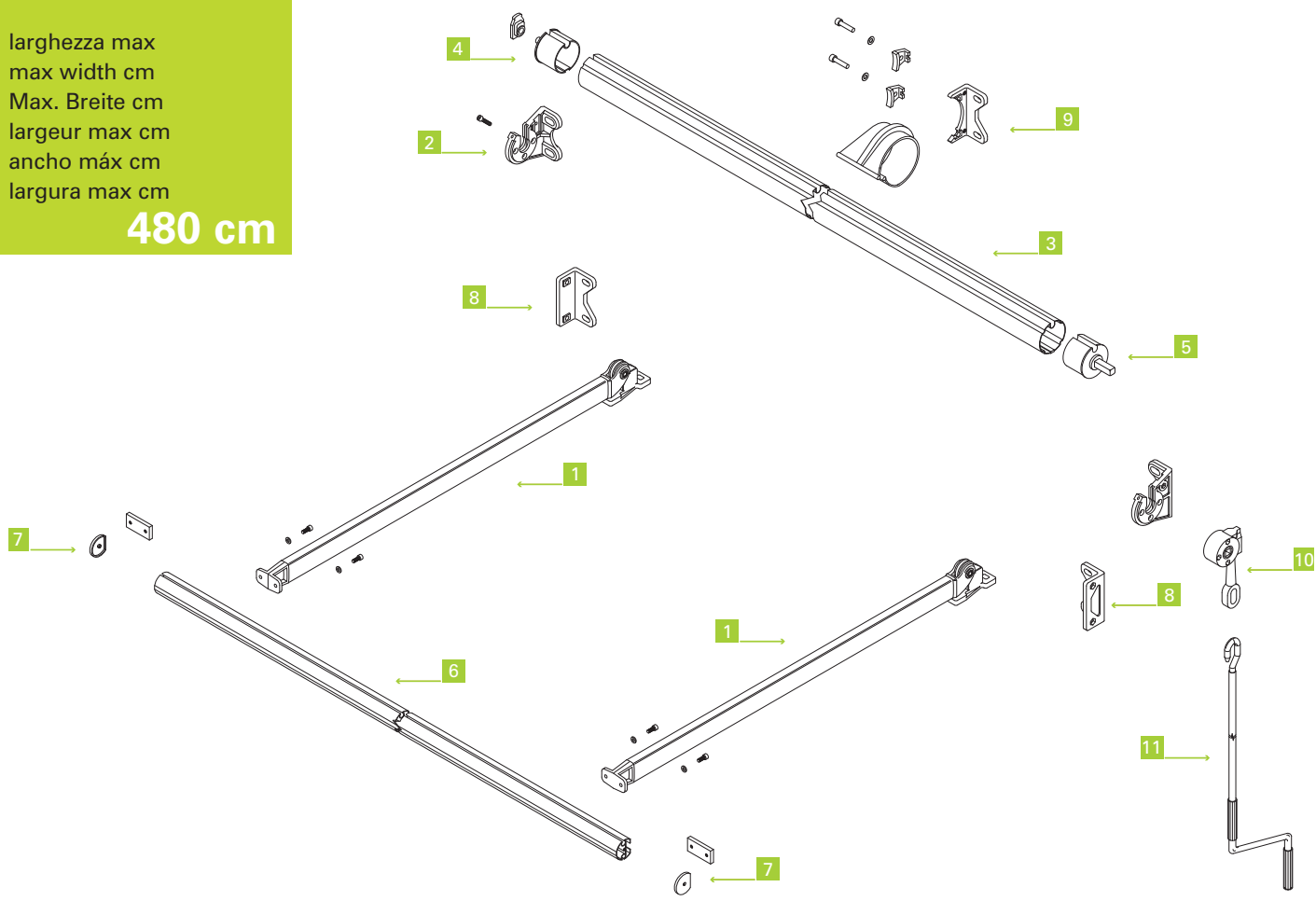



MAIN ARM / OPTIONAL ARM





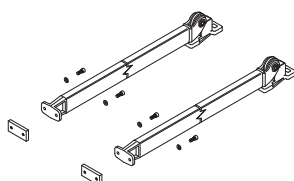
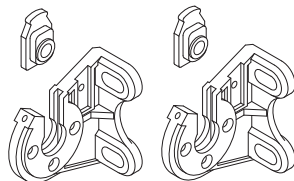
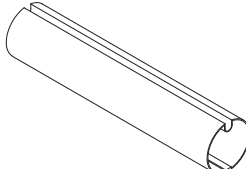
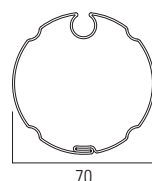
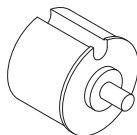
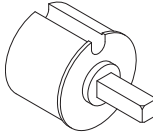
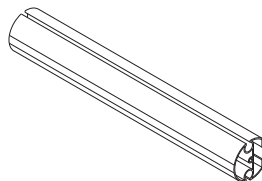
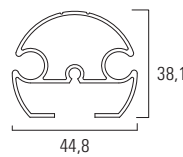

braccio principale
 main arm
 standard Arm
 bras principal
 brazo principal
 braço principal

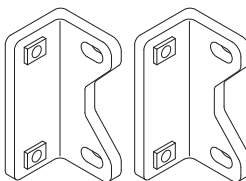
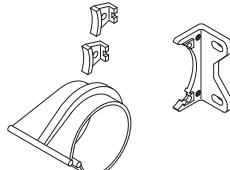
braccio opzionale
 optional arm
 optionaler Arm
 bras en option
 brazo opcional
 braço opcional

VANVITELLI

///

N°						€
1		6XL080 6XL100 6XL120 6XL140	braccio vanvitelli vanvitelli arm Gelenkarm Vanvitelli bras vanvitelli brazo vanvitelli braço vanvitelli		80 cm 100 cm 120 cm 140 cm	1 CP
2		936XL	staffa per caduta con piastrina nylon drop-brackets with nylon small plate Ausfallstütz mit Nylon-Plättchen étriers de descente avec plaquette nylon soporte de caída con plaquita nylon suporte de caído com pratinho nylon			10 CP
3		RULA70X10/10L4000 RULA70X10/10L5000 RULA70X10/10L6000 RULA70X10/10L7000	tubo avvolgitore Ø 70 (10/10) Ø 70 roller tube (10/10) Tuchwelle Ø 70 (10/10) tubo de enroule Ø 70 (10/10) tubo enrolador Ø 70 (10/10)		400 cm 500 cm 600 cm 700 cm	4 PZ
4		2XL911PT7	calotta in nylon Ø 70 perno tondo 12x20 Ø 70 nylon cap with 12x20 round pin Nylon-Wellenkapsel Ø 70 mit 12x20 mm Rundstift calotte en nylon Ø 70 pivot rond 12x20 casquillo de nylon Ø 70 perno redondo 12x20 calote em nylon Ø 70 eixo redondo 12x20			1 PZ
5		2XL911PQ7	calotta in nylon Ø 70 perno quadro 13x40 Ø 70 nylon cap with 13x40 square pin Nylon-Wellenkapsel Ø 70 mit 13x40 Vierkantstift calotte en nylon Ø 70 pivot carré 13x40 casquillo en nylon Ø 70 perno cuadrado 13x40 calote em nylon Ø 70 eixo quadrado 13x40			1 PZ
6		ESTRTTL4800 ESTRTTL7000	terminale tondo round terminal bar Runde Ende-Ausfallprofil barre de charge ronde barra de carga redonda barra terminal redonda		480 cm 700 cm	1 PZ
7		939TTT	tappo pvc terminale tondo round terminal bar PVC cap PVC-Deckel für Rundprofil bouchon pvc barre de charge ronde tapa pvc barra de carga redonda tampa PVC barra terminal redonda			1 CP
8		937XL	staffetta laterale side bracket Seitenführung Träger équerre latérale soporte lateral estribo lateral			1 CP
9		6XL908	supporto compensatore TC TC balance support TC-Ausgleichsstütz support compensateur TC soporte compensador TC suporte compensador TC			1 PZ

N°					€
10		PFARG7/1	arganello 7/1 reduction winch 7/1 Wunsch 7/1 treuil 7/1 máquina sinfín 7/1 sarilho 7/1	1 PZ	
11		PFASM100 PFASM120 PFASM150 PFASM180 PFASM200 PFASM220 PFASM250 PFASM300	asta manovra crank rod Bedienungsstange manivelle manivela manivela	100 cm 120 cm 150 cm 180 cm 200 cm 220 cm 250 cm 300 cm	

OPTIONAL

optional disponibili per questa tenda
extras available for this awning

vorhandene Möglichkeiten für diese Markise
options disponibles pour ce store

opciones disponibles para este toldo
opções disponíveis para este toldo

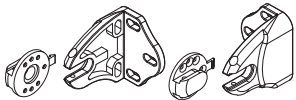
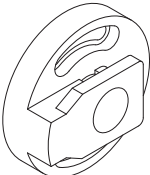
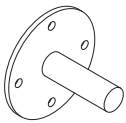
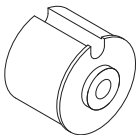
	972XL	staffetta prada con ruota prada bracket with roller Prada Konsole mit Rolle étrier prada avec roue soporte Prada con rueda suporte Prada com rodas	1 CP	
	941SA	piastrina porta argano plate for gear Winschträger-Plakette plaquette porte-treuil soporte para máquina sinfín plaqueta leva sarilho	1 PZ	
	PIVOT	pivot pin Plättchen mit Stift pivot pivote pivô	1 PZ	
	2XL910F7	calotta in nylon Ø 70 con foro Ø 70 nylon cap with hole Nylon-Wellenkapsel Ø 70 mit rundem Loch calotte en nylon d Ø 70 avec trou casquillo de nylon Ø 70 con agujero calote em nylon Ø 70 com furo	1 PZ	

GUERCINO

altezza max
 max height
 maximale Höhe
 hauteur max
 salida máx
 saliência máxima

300 cm

larghezza max
 max width cm
 Max. Breite cm
 largeur max cm
 ancho máx cm
 largura max cm

480 cm

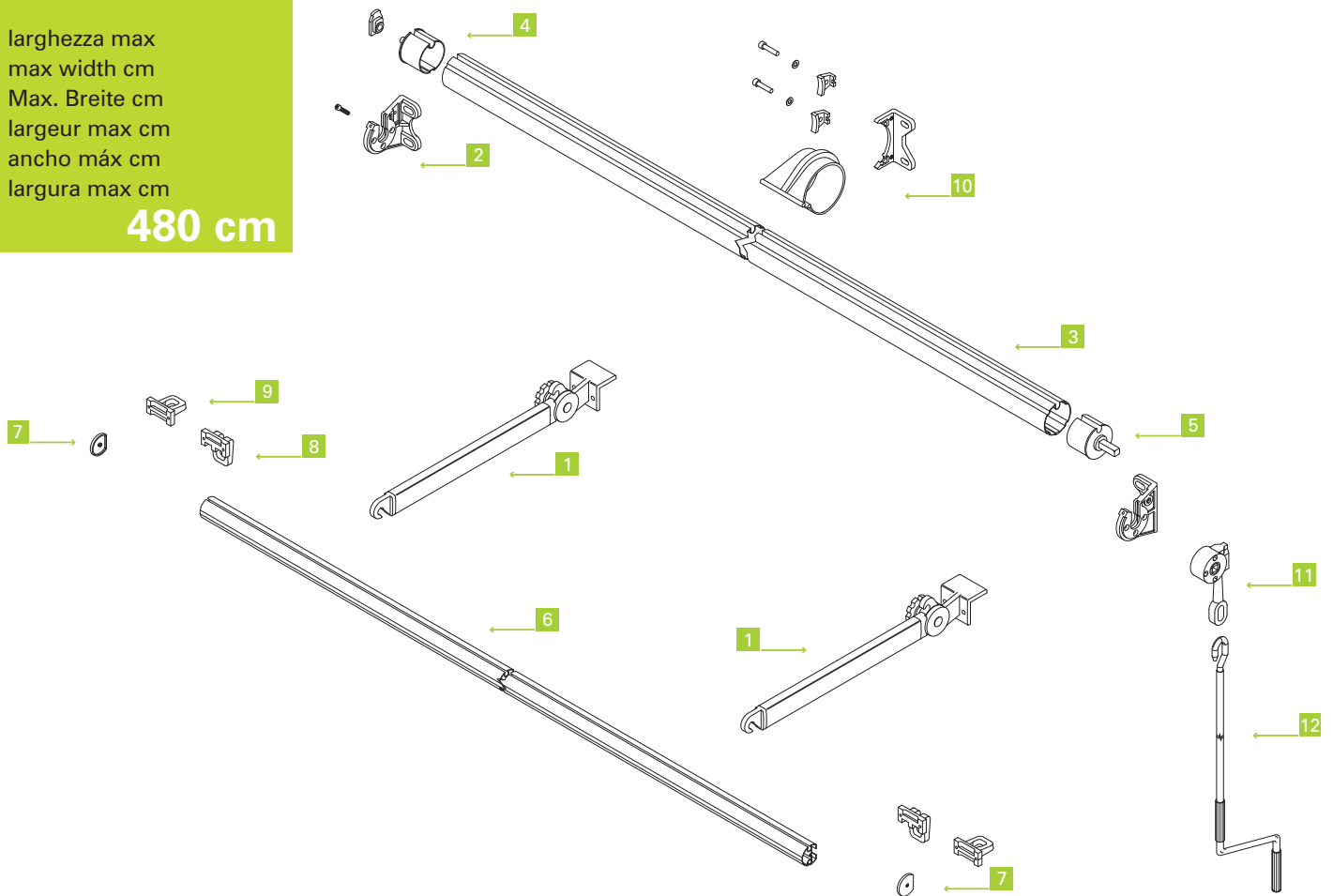





MAIN ARM / OPTIONAL ARM





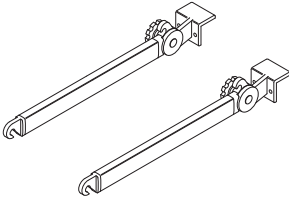
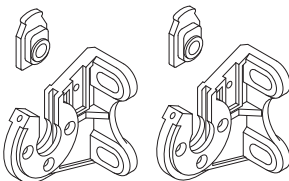
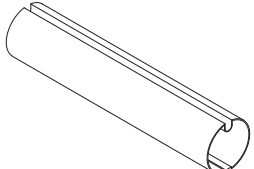
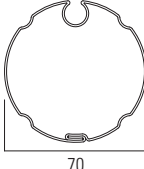

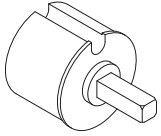
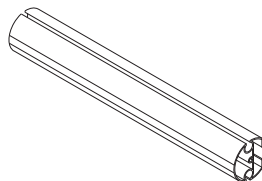
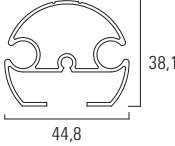
braccio principale
 main arm
 standard Arm
 bras principal
 brazo principal
 braço principal

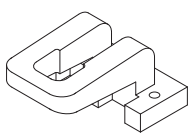
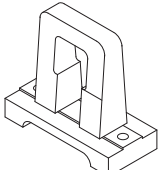
braccio opzionale
 optional arm
 optionaler Arm
 bras en option
 brazo opcional
 braço opcional

GUERCINO

///

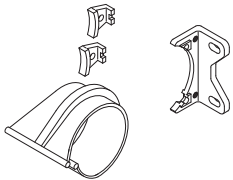
N°						
1		5XL50 5XL100	braccio guercino guercino arm Gelenkarm Guercino bras guercino brazo guercino braço guercino		50 cm 100 cm	1 CP
2		936XL	staffa per caduta con piastrina nylon drop-brackets with nylon small plate Ausfallstütz mit Nylon-Plättchen étriers de descente avec plaquette nylon soporte de caída con plaquita nylon suporte de caído com pratinho nylon			10 CP
3		RULA70X10/10L4000 RULA70X10/10L5000 RULA70X10/10L6000 RULA70X10/10L7000	tubo avvolgitore Ø 70 (10/10) Ø 70 roller tube (10/10) Tuchwelle Ø 70 (10/10) tubo enrouleur Ø 70 (10/10) tubo de enrollar Ø 70 (10/10) tubo enrolador Ø 70 (10/10)		400 cm 500 cm 600 cm 700 cm	4 PZ
4		2XL911PT7	calotta in nylon Ø 70 perno tondo 12x20 Ø 70 nylon cap with 12x20 round pin Nylon-Wellenkapsel Ø 70 mit 12x20 mm Rundstift calotte en nylon Ø 70 pivot rond 12x20 casquillo de nylon Ø 70 perno redondo 12x20 calote em nylon Ø 70 eixo redondo 12x20			1 PZ
5		2XL911PQ7	calotta in nylon Ø 70 perno quadro 13x40 Ø 70 nylon cap with 13x40 square pin Nylon-Wellenkapsel Ø 70 mit 13x40 mm Vierkantstift calotte en nylon Ø 70 pivot carré 13x40 casquillo en nylon Ø 70 perno cuadrado 13x40 calote em nylon Ø 70 eixo quadrado 13x40			1 PZ
6		ESTRTTL4800 ESTRTTL7000	terminale tondo round terminal bar Runde Ende-Ausfallprofil barre de charge ronde barra de carga redonda barra terminal redonda		480 cm 700 cm	1 PZ
7		939TTT	tappo pvc terminale tondo round terminal bar PVC cap PVC-Deckel für Rundprofil bouchon pvc barre de charge ronde tapa pvc barra de carga redonda tampa PVC barra terminal redonda			1 CP
8		PF938C	occhiolo curvo nylon nylon curved eyelet Nylon- gekrümmte Öse oeillet courbé en nylon ojal de nylon curvado ilhós de nylon curvo			1 PZ
9		PF938B	occhiolo dritto nylon nylon straight eyelet Nylon-gerade Öse oeillet droit en nylon ojal de nylon recto ilhós de nylon reto			1 PZ

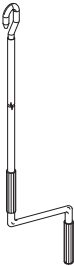

N°						€
10		6XL908	<p>supporto compensatore TC</p> <p>TC balance support</p> <p>TC-Ausgleichsstütz</p> <p>support compensateur TC</p> <p>soporte compensador TC</p> <p>suporte compensador TC</p>		1 PZ	
11		PFARG7/1	<p>arganello 7/1</p> <p>reduction winch 7/1</p> <p>Winsch 7/1</p> <p>treuil 7/1</p> <p>máquina sinfín 7/1</p> <p>sarilho 7/1</p>		1 PZ	
12		<p>PFASM100</p> <p>PFASM120</p> <p>PFASM150</p> <p>PFASM180</p> <p>PFASM200</p> <p>PFASM220</p> <p>PFASM250</p> <p>PFASM300</p>	<p>asta manovra</p> <p>crank rod</p> <p>Bedienungsstange</p> <p>manivelle</p> <p>manivela</p> <p>manivela</p>	<p>100 cm</p> <p>120 cm</p> <p>150 cm</p> <p>180 cm</p> <p>200 cm</p> <p>220 cm</p> <p>250 cm</p> <p>300 cm</p>	10 PZ	

OPTIONAL

optional disponibili per questa tenda
extras available for this awning

vorhandene Möglichkeiten für diese Markise
options disponibles pour ce store

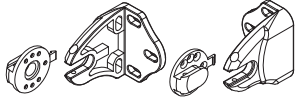
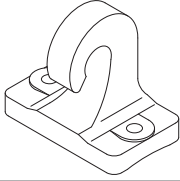
opciones disponibles para este toldo
opções disponíveis para este toldo

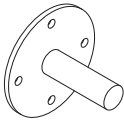
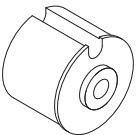
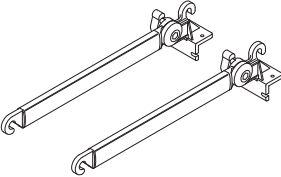
	<p>972XL</p>	<p>staffetta prada con ruota prada bracket with roller Prada Konsole mit Rolle étrier prada avec roue soporte Prada con rueda suporte Prada com rodas</p>		<p>1 CP</p>	
	<p>PF938A</p>	<p>gancio nylon nylon hook Haken PVC crochet nylon gancho nylon gancho nylon</p>		<p>1 PZ</p>	
	<p>941SA</p>	<p>piastrina porta argano plate for gear Winschträger-Plakette plaquette porte-treuil soporte para máquina sinfín plaqueta leva sarilho</p>		<p>1 PZ</p>	
	<p>PIVOT</p>	<p>pivot pin Plättchen mit Stift pivot pivoté pivô</p>		<p>1 PZ</p>	
	<p>2XL910F7</p>	<p>calotta in nylon Ø 70 con foro Ø 70 nylon cap with hole Nylon-Wellenkapsel Ø 70 mit rundem Loch calotte en nylon d Ø 70 avec trou casquillo de nylon Ø 70 con agujero calote em nylon Ø 70 com furo</p>		<p>1 PZ</p>	
	<p>5XLSPE</p>	<p>braccio guercino export guercino export arm Gelenkarm Guercino export bras guercino export brazo guercino export braço guercino export</p>		<p>1 CP</p>	

AVAILABLE COLOURS

	RAL9010	RAL7035	RAL1013	OTHER RAL
ANTONELLI	STANDARD	STANDARD	STANDARD	to be quoted
CANALETTO	STANDARD	+ 10%	+ 10%	to be quoted
BELLINI	STANDARD	+ 10%	+ 10%	to be quoted
VANVITELLI	STANDARD	STANDARD	STANDARD	to be quoted
GUERCINO	STANDARD	STANDARD	STANDARD	to be quoted

RAL: ALTRI | OTHER | ANDERE | AUTRES | OTROS | OUTROS

preventivo - quote - Angebot - devis - presupuesto - cotação



tende a bracci
su barra quadra

Gelenkarmmarkisen
auf Vierkant-Tragrohr

toldos con brazos
sobre barra cuadrada

folding arm awnings
on square bar

stores a bras
articulés sur barre carrée

toldos com braços
sobre barra quadrada



tende a bracci
su staffe indipendenti

Tragrohrlose Markisen auf
unabhängige Armträger

toldos con brazos sobre
soportes independientes

folding arm awnings
on independent brackets

stores à bras en
étriers indépendants

toldos com braços sobre
estribos independentes



tende a bracci
con cassonetto

Kassettenmarkisen

toldos con brazos
con cajón

folding arm awnings
with cassette

stores à bras
avec coffre

toldos com braços
e caixote



tende a caduta

Fallarm Markisen

toldos de caída

drop awnings

stores à descente

toldos enroscáveis



tende per veranda

Terrassenbeschattungen

toldos para terrazas

veranda awnings

stores pour vérandas

toldos para varandas



cappottine

Korbmarkisen

capotas

canopies

corbeilles

capotes



gamma bracci &
accessori

Gelenkarme und
Zubehöre-Serie

gama brazos y
accesorios

arms' &
components' range

gamme de bras &
accessoires

gama braços &
acessórios



euroflex A TOUCH OF SHADE

euroflex srl

via pacinotti, 14 | 35030

rubano (padova) Italia

T +39 049 629588

T +39 049 8933183

F +39 049 629703

info@euroflex.cc

www.euroflex.cc

FLEX PRICE CAMÕES