

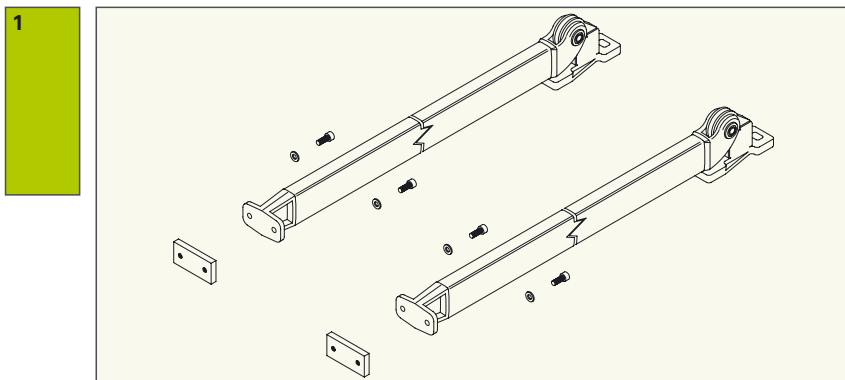













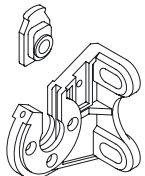
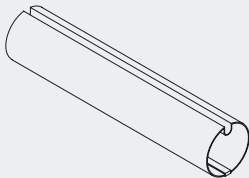
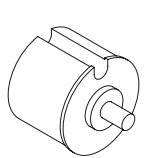

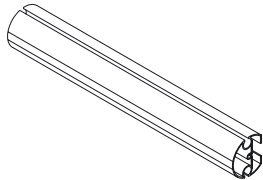

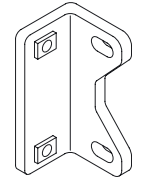
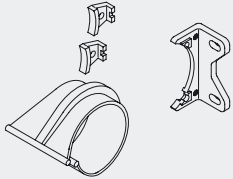
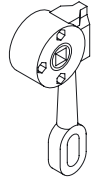
braccio Vanvitelli - Vanvitelli arm - Gelenkarm Vanvitelli - bras Vanvitelli

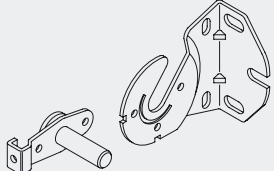
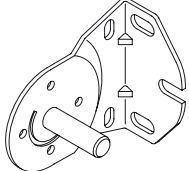
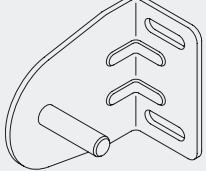

n°				€
1	6XL080 6XL100 6XL120 6XL140	80 cm 100 cm 120 cm 140 cm	braccio Vanvitelli Vanvitelli arm Gelenkarm Vanvitelli bras Vanvitelli	1 CP

n°					
2	936XL		<p>staffa per caduta con piastrina nylon <i>brackets with nylon pin</i> Wand - Deckenkonsole <i>paire d'étriers avec plaquette nylon</i></p>	1 PZ	
3	RULA70X10/10		<p>tubo avvolgitore Ø 70 (10/10) <i>Ø 70 roller tube (10/10)</i> Tuchwelle Ø 70 (10/10) <i>tube enrouleur Ø 70 (10/10)</i></p>	1 ML	
4	2XL911PT7		<p>calotta in nylon Ø 70 perno tondo 12x20 <i>Ø 70 nylon cap with 12x20 round pin</i> Wellenkapsel nylon Ø 70 Rundstift 12x20 <i>calotte en nylon Ø 70 pivot rond 12x20</i></p>	1 PZ	
5	2XL911PQ7		<p>calotta in nylon Ø 70 perno quadro 13x40 <i>Ø 70 nylon cap with 13x40 square pin</i> Wellenkapsel nylon Ø 70 mit Vierkantstift 13x40 <i>calotte en nylon Ø 70 pivot carré 13x40</i></p>	1 PZ	
6	ESTRIT		<p>terminale tondo <i>round terminal bar</i> Runde Fallstange <i>barre de charge ronde</i></p>	1 ML	
7	939TTT		<p>tappo pvc terminale tondo <i>round terminal bar PVC end cover</i> PVC Fallstangendeckel rund <i>bouchon pvc barre de charge ronde</i></p>	1 CP	
8	937XL		<p>staffetta laterale <i>side bracket</i> Seiten Träger <i>équerre latérale</i></p>	1 CP	
9	6XL908		<p>supporto compensatore TC <i>TC balance support</i> Stützlager TC <i>support compensateur TC</i></p>	1 PZ	
10	PFARG7/1		<p>arganello 7/1 <i>reduction winch 7/1</i> Getriebe 7/1 <i>treuil 7/1</i></p>	1 PZ	

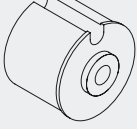
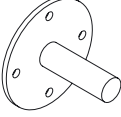
n°	<table border="1"> <tr><td>G</td><td>Y</td><td>G</td></tr> <tr><td>A</td><td>3</td><td>S</td></tr> <tr><td>1</td><td>8</td><td><</td></tr> </table>	G	Y	G	A	3	S	1	8	<				
G	Y	G												
A	3	S												
1	8	<												
11	PFASM100 PFASM120 PFASM150 PFASM180 PFASM200 PFASM220 PFASM250 PFASM300		asta manovra <i>crank rod</i> Kurbelstab <i>manivelle</i>	100 cm 120 cm 150 cm 180 cm 200 cm 220 cm 250 cm 300 cm	1 PZ									
	938XLZVPE		staffe con perno estraibile <i>brackets with sliding pin</i> Träger mit abnehmbaren Bolzen <i>paire d'étriers avec pivot extractible</i>		1 CP									
	939XLZVP		staffe con perno fisso <i>brackets with fixed pin</i> Träger mit Bolzen <i>paire d'étriers avec pivot fixe</i>		1 CP									
	940XLZVP		staffe pesanti con perno <i>heavy brackets with pin</i> Träger mit Bolzen <i>paire d'étriers lourds avec pivot</i>		1 CP									
	941SA		piastrina porta argano <i>plate for gear</i> Plakette für Getriebe <i>plaquette porte-treuil</i>		1 PZ									
	2XL910F7		calotta in nylon Ø 70 foro tondo <i>Ø 70 nylon cap with round hole</i> Wellenkapsel mit Rundstift Ø 70 <i>calotte en nylon Ø 70 trou rond</i>		1 PZ									
	PIVOT		pivot <i>pin</i> Plättchen mit Stift <i>pivot</i>		1 PZ									