

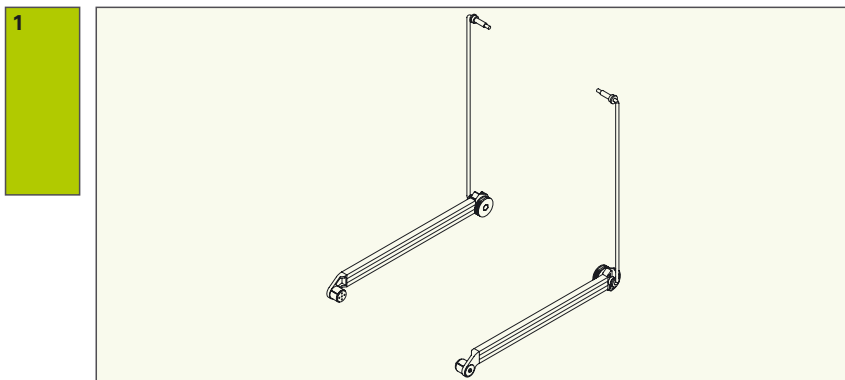











braccio Canaletto - Canaletto arm - Gelenkarm Canaletto - bras Canaletto

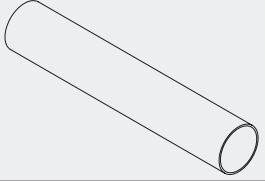
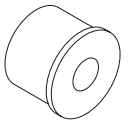

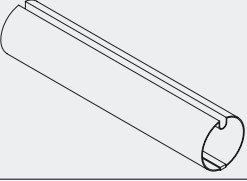
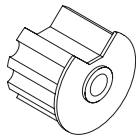
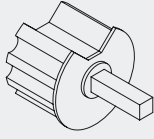
n°				€
1	10XL60	60 cm	braccio Canaletto Canaletto arm Gelenkarm Canaletto bras Canaletto	1 CP

n°					
2	10XLSTP		testata con perno TC <i>TC head with pin</i> Console mit Bolzen TC <i>support tête avec pivot TC</i>	1 PZ	
3	10XLSA		arganello TC <i>TC reduction winch</i> Getriebe TC <i>support avec treuil TC</i>	1 PZ	
4	RULA60X8/10		tubo avvolgitore Ø 60 <i>Ø 60 roller tube</i> Tuchwelle Ø 60 <i>tube enrouleur Ø 60</i>	1 ML	
5	10XLBT6		calotta in nylon Ø 60 foro tondo <i>Ø 60 nylon cap with round hole</i> Wellenkapsel mit Rundstift Ø 60 <i>calotte en nylon Ø 60 trou rond</i>	1 PZ	
6	10XLBQ6		calotta in nylon Ø 60 perno quadro <i>Ø 60 nylon cap with square pin</i> Wellenkapsel mit Vierkantstift Ø 60 <i>calotte en nylon Ø 60 pivot carré</i>	1 PZ	
7	10XLRO		rondella pvc TC <i>TC pvc washer</i> PVC Rolle TC <i>rondelle pvc TC</i>	1 PZ	
8	10XLGLAT		guida laterale <i>side profile guide</i> Seiten Führung <i>guidage latéral</i>	1 ML	
9	10XLGR		gruppo arresto <i>stop joint for arms</i> Einstell Satz für Arme <i>groupe d'arrêt</i>	1 PZ	
10	10XLFE		ferma asta <i>crank rod clic</i> Kurbelstab halter <i>arrêt manivelle</i>	1 PZ	

n°						
11	10XLPI		supporto piede regolabile <i>adjustable foot</i> Bewegliche Zapfenlagerung für Führung <i>support pied réglable</i>		1 PZ	
12	10XLTFRAN		tubo frangivento <i>windbreaker</i> Windbrecherrohr <i>tube brise-vent</i>		1 ML	
13	10XLMK		innesto tubo frangivento <i>cap for windbreaker</i> Lager für Windbrecher <i>raccord tube brise-vent</i>		1 PZ	
14	10XLTAS		terminale asolato <i>terminal bar</i> Fallstangenkupplung <i>barre de charge perforée</i>		1 ML	
15	PFASM100 PFASM120 PFASM150 PFASM180 PFASM200 PFASM220 PFASM250 PFASM300		asta manovra <i>crank rod</i> Kurbelstab <i>manivelle</i>	100 cm 120 cm 150 cm 180 cm 200 cm 220 cm 250 cm 300 cm	1 PZ	
	RULA70X10/10		tubo avvolgitore Ø 70 (10/10) <i>Ø 70 roller tube (10/10)</i> Tuchwelle Ø 70 (10/10) <i>tube enroueur Ø 70 (10/10)</i>		1 ML	
	10XLBT7		calotta in nylon Ø 70 foro tondo <i>Ø 70 nylon cap with round hole</i> Wellenkapsel mit Loch Ø 70 <i>calotte en nylon Ø 70 trou rond</i>		1 PZ	
	10XLBQ7		calotta in nylon Ø 70 perno quadro <i>Ø 70 nylon cap with square pin</i> Wellenkapsel mit Vierkantstift Ø 70 <i>calotte en nylon Ø 70 pivot carré</i>		1 PZ	

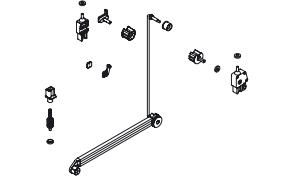
n°	<table border="1"> <tr><td>6</td><td>Y</td><td>G</td></tr> <tr><td>A</td><td>3</td><td>S</td></tr> <tr><td>1</td><td>8</td><td><</td></tr> </table>	6	Y	G	A	3	S	1	8	<				
6	Y	G												
A	3	S												
1	8	<												
10XLT4		<p>kit canaletto: 1+2+3+5+6+7(x5)+9(x2)+10+11(x2)+13(x2) <i>kit canaletto: 1+2+3+5+6+7(x5)+9(x2)+10+11(x2)+13(x2)</i> kit canaletto: 1+2+3+5+6+7(x5)+9(x2)+10+11(x2)+13(x2) <i>kit canaletto: 1+2+3+5+6+7(x5)+9(x2)+10+11(x2)+13(x2)</i></p>	1 PZ											