

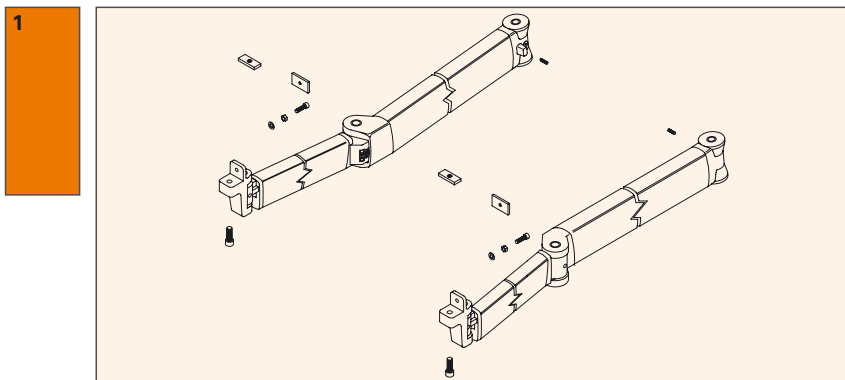











braccio Orion - Orion arm - Orion Gelenkarm - bras Orion

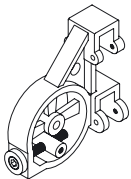
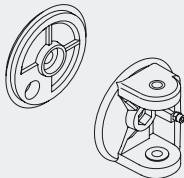
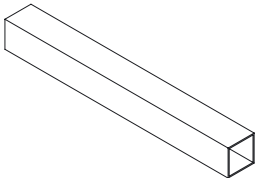
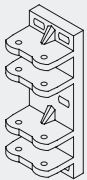
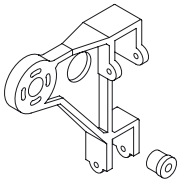
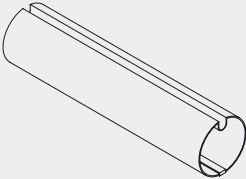
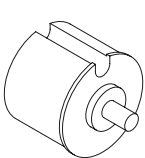
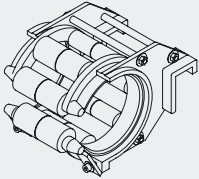
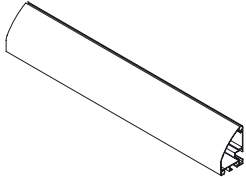

n°					€
1	1XL400 1XL450 1XL500 1XL550	400 cm 450 cm 500 cm 550 cm	braccio Orion Orion arm Gelenkarm Orion bras Orion	1 CP	

n°					
2	1XL902		supporto braccio michelangelo <i>michelangelo arm support</i> Armkonsole michelangelo <i>support bras michelangelo</i>	1 CP	
3	1XL900A		disco completo michelangelo <i>michelangelo complete disk for arm support</i> Armscheibe komplett michelangelo <i>disque complet michelangelo</i>	1 CP	
4	BQ40X40		barra quadra mm 40x40 <i>40x40 mm square bar</i> Tragrohr 40x40 mm <i>barre carrée 40x40 mm</i>	1 ML	
5	1XL903		staffa parete michelangelo <i>michelangelo wall bracket</i> Wandkonsole michelangelo <i>étrier mur michelangelo</i>	1 PZ	
6	1XL906		supporto tubo avvolgitore con boccia michelangelo <i>michelangelo roller tube support with bush</i> Tuchwellenlager michelangelo <i>support tube enrouleur avec virole michelangelo</i>	1 CP	
7	RULA78X10/10		tubo avvolgitore Ø 78 (10/10) <i>Ø 78 roller tube (10/10)</i> Tuchwelle Ø 78 (10/10) <i>tube enrouleur Ø 78 (10/10)</i>	1 ML	
8	2XL912PT78		calotta in nylon Ø 78 perno tondo 12x20 <i>Ø 78 nylon cap with 12x20 hole</i> Wellenkapsel nylon Ø 78 mit Rundstift 12x20 <i>calotte en nylon Ø 78 pivot rond 12x20</i>	1 PZ	
9	1XL908		supporto compensatore con ruote michelangelo <i>michelangelo balance support with rollers</i> Rollen Stützlager michelangelo <i>support compensateur avec roues michelangelo</i>	1 PZ	
10	ESTRGIG		terminale gigante <i>large terminal bar</i> Leichte Fallstange Lux <i>barre de charge géante</i>	1 ML	

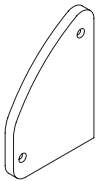
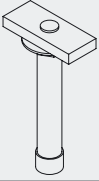
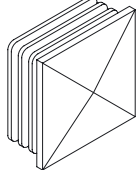
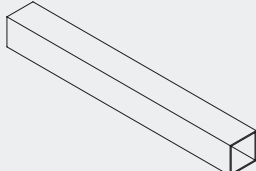
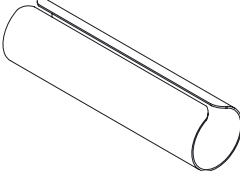
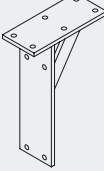
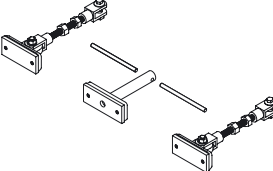
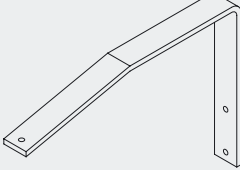
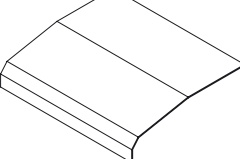
n°					
11	1XL934		<p>tappo alluminio terminale gigante <i>large terminal profile aluminium end covers</i> Grosse Fallstangendeckel <i>bouchon aluminium barre de charge géante</i></p>	1 CP	
12	1XL929		<p>perno raccoglibraccio <i>arm folding checkpin</i> Armhalterung mit Bolzen <i>pivot ramassage bras</i></p>	1 CP	
13	PFTAPBQ		<p>tappo PVC per barra quadra mm 40x40 <i>40x40 mm square bar PVC end cover</i> PVC Deckel 40x40 mm <i>bouchon PVC bq 40x40 mm</i></p>	1 CP	
14	GIUN1		<p>giunzione 35x35 mm per barra quadra e terminali <i>35x35 mm square bar and terminal bar joint</i> Fallstangen und Tragrohr Kupplung 35x35 mm <i>jonction diam Q35x35 pour barre carrée et barres de charge</i></p>	1 PZ	
15	GIUN3		<p>giunzione per tubo avvolgitore Ø 78 <i>Ø 78 joint roller tube support</i> Tuchwellen Kupplung Ø 78 <i>jonction Ø 78 support tube enrouleur</i></p>	1 PZ	
	1XL925		<p>staffa soffitto <i>ceiling bracket</i> Deckenkonsole <i>étrier de fixation plafond</i></p>	1 PZ	
	1XLCT		<p>centina terminale gigante <i>giant terminal centring</i> Spannsatz für Fallstange <i>cintre pour barre de charge géante</i></p>	1 PZ	
	MENATTET		<p>staffe per tettuccio <i>hood brackets</i> Schutzdach Konsolen <i>consoles fixation auvent</i></p>	1 PZ	
	TETALVERN		<p>tettuccio alluminio verniciato <i>aluminium painted hood</i> Schutzdach pulverbeschichtet <i>auvent aluminium peint</i></p>	1 ML	