



tubo avvolgitore Ø 60
 Ø 60 roller tube
 Tuchwelle Ø 60
 tube enrouleur Ø 60



tubo avvolgitore Ø 70
 Ø 70 roller tube
 Tuchwelle Ø 70
 tube enrouleur Ø 70



tubo avvolgitore Ø 78
 Ø 78 roller tube
 Tuchwelle Ø 78
 tube enrouleur Ø 78



giunzione per tubo avvolgitore
 joint roller tube support
 Tuchwellen Kupplung
 jonction support tube enrouleur

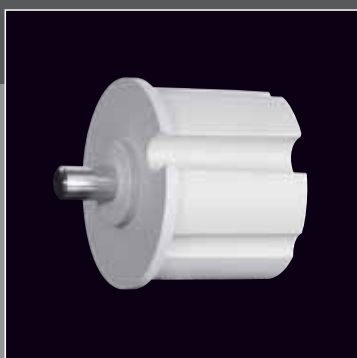

calotta in nylon Ø 78 perno tondo
 Ø 78 nylon cap with hole
 Wellenkapsel nylon Ø 78 mit Rundstift
 calotte en nylon Ø 78 pivot rond



calotta in nylon Ø 78 con foro
 Ø 78 nylon cap with hole
 Wellenkapsel nylon Ø 78 mit Loch
 calotte en nylon d Ø 78 avec trou



calotta in nylon Ø 78 perno quadro
 Ø 78 nylon cap with square pin
 Wellenkapsel nylon Ø 78 mit Vierkantstift
 calotte en nylon Ø 78 pivot carré



calotta in nylon Ø 78 con foro
 Ø 78 nylon cap with hole
 Wellenkapsel nylon Ø 78 mit Loch
 calotte en nylon d Ø 78 avec trou

accessori

components

Komponenten

accessoires



calotta in nylon Ø 60 foro tondo
Ø 60 *nylon cap with round hole*
Wellenkapsel mit Rundstift Ø 60
calotte en nylon Ø 60 trou rond



calotta in nylon Ø 60 perno quadro
Ø 60 *nylon cap with square pin*
Wellenkapsel mit Vierkantstift Ø 60
calotte en nylon Ø 60 pivot carré



calotta in nylon Ø 70 foro tondo
Ø 70 *nylon cap with round hole*
Wellenkapsel mit Rundstift Ø 70
calotte en nylon Ø 70 trou rond



calotta in nylon Ø 78 perno quadro
Ø 78 *nylon cap with square pin*
Wellenkapsel nylon Ø78 mit Vierkantstift
calotte en nylon Ø 78 pivot carré



arganello
reduction winch
Getriebe
treuil



arganello
reduction winch
Getriebe
treuil



arganello
reduction winch
Getriebe
treuil

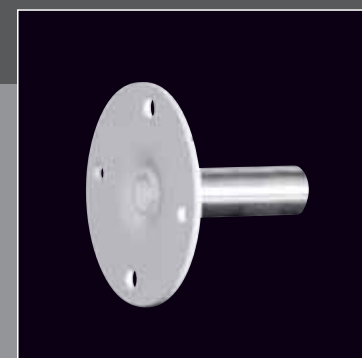

Pivot
Pin
Plättchen mit Stift
pivot

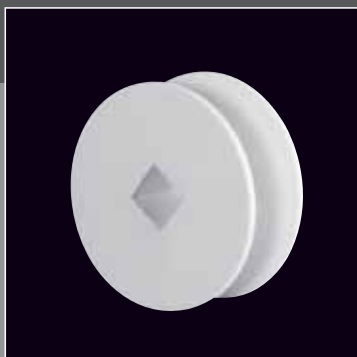

ruota PVC foro quadro
PVC wheel with square hole
PVC Rollen mit Vierkantloch
roue PVC trou carré

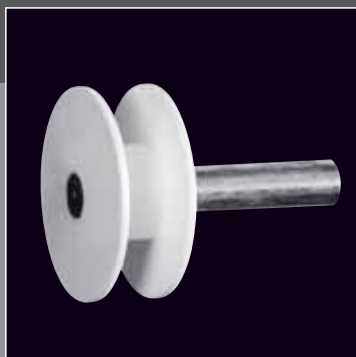

ruota PVC con perno tondo
PVC wheel with round pin
PVC Rollen mit Rundstift
roue PVC avec pivot rond

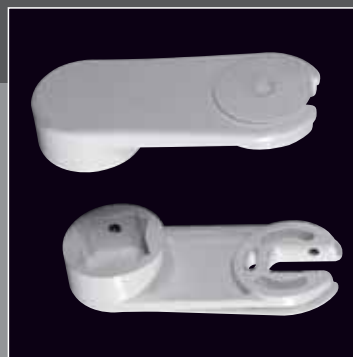

supporto tubo avvolgitore T40
T40 roller tube support
Tuchwellenlager
support tube enrouleur T40

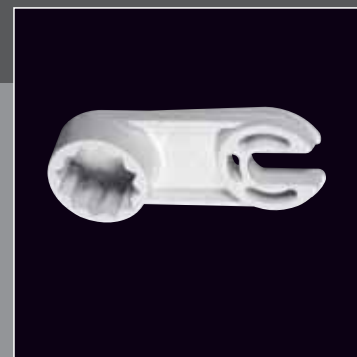

T40 inclinazione variabile
adjustable inclination T40
Neigungsverstellung
T40 à inclinaison variable



supporto braccio
arm support
Armkonsole
support bras



supporto braccio
arm support
Armkonsole
support bras

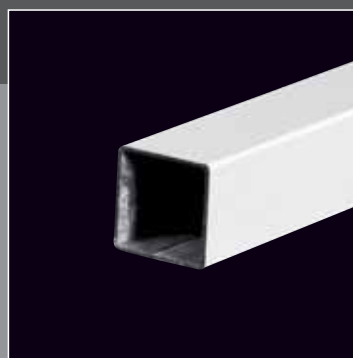

giunzione barra quadrata e terminali
square bar and terminal bar joint
Fallstangen und Tragrohr Kupplung
jonction barre carrée et barres de charge



tappo PVC per barra quadrata mm 35x35
35x35 mm square bar PVC end cover
Deckel PVC 35 x 35 mm
bouchon PVC bq 35x35 mm

accessori

components

komponenten

accessoires

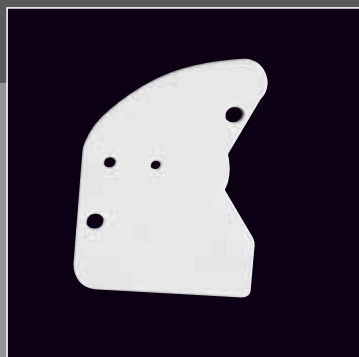

tappo PVC terminale pesante
PVC heavy terminal bar end cover
Fallstangen Deckel PVC
bouchon PVC barre de charge lourde

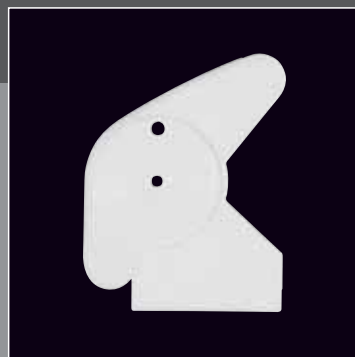

tappo PVC terminale leggero
PVC light terminal bar end cover
Fallstangen Deckel PVC
bouchon PVC barre de charge légère



piastrina porta argano
plate for gear
Plakette für Getriebe
plaquette porte-treuil



asta manovra
crank rod
Kurbelstab
manivelle



tappo PVC per barra quadra mm 40x40
40x40 mm square bar PVC end cover
Deckel PVC 40 x 40 mm
bouchon PVC bq 40x40 mm



barra quadra mm 35x35
35x35 mm square bar
Schnurrolle Verzinkt 35 x 35 mm
barre carrée 35x35 mm



barra quadra mm 40x40
40x40mm square bar
Tragrohr 40x40 mm
barre carrée 40x40 mm